

Pioneer *sound.vision.soul*

DVD-V8000

Industrial DVD Player

RS-232C

COMMAND PROTOCOL MANUAL

Manual Version 1.01

Jun 26, 2006

Pioneer Corporation
Pioneer Electronics (USA), Inc.

This manual is copyrighted with all rights reserved. No part of this document may be reprinted, produced, translated or utilized in any form or by any means now known or hereafter invented including, but not limited to, any electronic, mechanical, photocopying and recording or information storage and retrieval system means, without the express written permission from Pioneer Electronics (USA), Inc.

Every effort has been made to ensure that the information in this manual is accurate. Pioneer is not responsible for printing or clerical errors.

Information in this document is subject to change without notice.

Copyright (c) 2006 Pioneer Electronics (USA), Inc.

Document No. [DVDV8000_CPMv101](#)
Printed in the United States of America.

Mention of third-party products is for informational purposes only and contributes neither an endorsement nor a recommendation. Pioneer assumes no responsibility with regard to the performance or use of these products.

No investigation has been made of common-law trademark rights in any word. Words that are known to have current registrations are shown with an initial capital. Many, if not all, hardware and/or software products referenced in this manual are identified by their trade names. Most, if not all, of these designations are claimed a legally protected trademarks by the companies that make the product. It is not Pioneer's intent to use any of these names generically and cautions the reader to investigate any claimed trademark before using it for any purpose other than to refer to the product to which the trademark is attached.

Pioneer makes no warranty of any kind, expressed or implied, about the contents of this manual, the merchantability of the product or the product's fitness for any particular purpose.

Every precaution has been taken in the preparation of this manual. Although we tried to thoroughly check that all instructions and information in this manual are accurate and correct, Pioneer can not be and is not responsible, in whole or in part, for any damage or loss to your data and/or equipment that results from your use of this document or from any information contained herein including, but not limited to, any errors, omissions or typos that may have resulted in an incorrect operation or installation.

FCC INFORMATION

The equipment described in this manual has been tested and found to comply with the limits for a Class B digital device in accordance with the specifications in Part 15 of FCC rules. These specifications are designed to provide reasonable protection against radio and television reception interference in a residential installation. There is no guarantee that interference will not occur in a particular installation.

To determine if your player is causing interference, turn the device OFF. If the player is causing the interference, try one or more of the following corrective measures:

- verify the cables and connectors between components are shielded.
- increase separation between the player and components.
- connect the changer into an outlet or circuit different from that which the components are connected.
- consult dealer or experienced radio/television technician for help.

The Federal Communications Commission offers a handbook that may help you with eliminating interference. The handbook is titled *Interference Handbook* (stock number 004-000-00493-1) and may be ordered from the U.S. Government Printing Office, Washington, D.C. 20402.

Warning: Any changes or modifications to this product that are not authorized by Pioneer could void the FCC Certification and negate the user's authority to operate the equipment.

DOC CLASS B COMPLIANCE

This digital apparatus does not exceed the Class B limits for radio noise emissions from digital apparatus set out in the radio interference regulations of the Canadian Department of Communications.

SAFETY CAUTION

Care should always be taken when working with electronic devices. To protect you and your DVD-V5000 player from damage or harm, it is important that you first read and then carefully follow the instructions in this documentation. Take particular care to heed all warnings and cautions marked on the unit and outlined in this document and the accompanying *DVD-V5000 Industrial Player Operating Instructions*. **IGNORING ANY OR ALL INSTRUCTIONS AND WARNINGS MAY CAUSE INJURY TO THE PERSON(S) OPERATING THE EQUIPMENT, DAMAGE TO THE PRODUCT OR BOTH.**

Table of Contents

1.	INTRODUCTION.....	1
2.	INTERFACE.....	2
2.1	Interface Connector	2
2.2	Serial Interface Pin Specification	2
2.3	Computer Control Functions	3
2.3.1	Serial Control (see Chapters 3, 4, 5 and 6)	3
2.3.2	Extend Terminal Control (see Chapter 9).....	3
2.3.3	External Power Control.....	3
3.	SERIAL CONTROL	5
3.1	Serial Interface Specifications.....	5
3.1.1	Signal Interface.....	5
3.1.2	Data Type	5
3.1.3	Data Transfer Speed (Baud Rate).....	5
3.2	Communication with a Computer.....	5
3.3	Command and Status	6
3.4	Error Messages	8
3.5	Initial Setting	8
4.	COMMAND STRUCTURE.....	9
4.1	Command Mnemonic.....	11
4.2	Argument	11
4.3	Command String.....	11
4.4	Status Returns	12
4.5	Error Message	12
4.6	Request Status Return	12
4.7	Timing	13
4.8	Start Timing Under Synchronized Playback (with several players)	14
5.	COMMAND DESCRIPTIONS	15
5.1	Open	15
5.2	Close.....	15
5.3	Reject.....	15
5.3.1	Reject.....	16
5.4	Start	16
5.5	Play.....	17
5.6	Pause.....	18
5.7	Still (DVD, VCD)	18
5.8	Step Forward (DVD, VCD).....	19
5.9	Step Reverse (DVD)	19

5.10	Scan Forward	20
5.11	Scan Reverse	20
5.12	Scan Stop	20
5.13	Multi-Speed Forward (DVD, VCD)	20
5.14	Multi-Speed Reverse (DVD)	20
5.15	Speed (DVD, VCD)	21
5.16	Search	22
5.17	Search & Play	23
5.18	Stop Marker	24
5.19	Lead-Out Symbol	26
5.20	Clear	26
5.21	Frame (DVD)	27
5.22	Block Number (CD)	27
5.23	Time (excludes discs without Time Codes)	28
5.24	Chapter (DVD)	28
5.25	Title (DVD)	28
5.26	Index (CD)	29
5.27	TRACK (CD, VCD)	29
5.28	Select Subtitle (DVD)	29
5.29	Select Audio (DVD)	30
5.30	Select Aspect (DVD)	30
5.31	Select Angle (DVD)	30
5.32	Select Parental-Level (DVD)	31
5.33	Audio Control (DVD, CD, VCD)	31
5.34	Video Control	32
5.35	Display Control	33
5.36	Key Lock	34
5.37	Stack Group Set (DVD)	35
5.38	Command Stack Play (DVD)	35
5.39	Stack Data Upload	36
5.40	Stack Data Download	39
5.41	Weekly Timer Data Upload	40
5.42	Weekly Timer Data Download	47
5.43	Output Select	48
5.44	DVD VR Play Mode (DVD VR)	48
5.45	Repeat Mode	49
5.46	General Purpose Parameter	49
5.47	Chapter Skip	51
6.	CURRENT PLAYER CONDITION REQUEST Descriptions	52
6.1	P-Block Number Request	52

6.2	Title/Track Number Request	52
6.3	Chapter Number Request (DVD)	53
6.4	Time Code Request	53
6.5	Block Number Request (CD)	53
6.6	Frame Number Request (DVD)	54
6.7	Index Number Request (CD)	54
6.8	Total Frame Request (DVD)	55
6.9	TOC Information Request	55
6.10	Disc Region Code Request (DVD).....	56
6.11	DVD Disc Status Request.....	56
6.12	CD Disc Status Request	57
6.13	Register A Set.....	58
6.14	Register D Set	60
6.15	Print Character.....	60
6.16	Clear Screen.....	61
6.17	Real Time Clock Set	61
6.18	Advanced Setup	62
6.19	Communication Control Set.....	64
6.20	Player Active Mode Request.....	64
6.21	Player Model Name Request	65
6.22	Real Time Clock Request	65
6.23	Advanced Setup Request	66
6.24	Player Region Code Request	66
6.25	CCR Mode Request.....	67
6.26	Input Number Request.....	67
6.27	Error Code Request	67
6.28	Input Unit Request	67
6.29	Register A Request.....	68
6.30	Register D Request	69
6.31	Menu Call (DVD).....	69
6.32	Numeric Button (DVD)	70
6.33	Button Select (DVD)	70
6.34	Enter Button (DVD).....	71
6.35	Get Information (DVD)	72
6.36	Memory Data Upload	74
6.37	Return Firmware Version	75
7.	OPERATING MODES.....	76
7.1	Open	76
7.2	Park	76
7.3	Setup	76

7.4	Random Access.....	76
7.5	Reject.....	77
8.	DVD-V8000 INTERNAL REGISTERS	78
8.1	Current Time/Frame	78
8.2	P-TIME.....	78
8.3	Current Title/Track (Current Chapter).....	78
8.4	Current Index.....	78
8.5	Serial Digit Buffer.....	78
8.6	Remote Control Use Address Flag.....	78
8.7	Remote Control Digit Buffer.....	78
8.8	Remote Control Data Register.....	79
8.9	Serial Use Address Flag.....	79
8.10	Search Time/Frame	79
8.11	Search Title/Track (Search Chapter).....	79
8.12	Search Index.....	79
8.13	Mark Time/Frame	79
8.14	Mark Title/Track (Mark Chapter).....	79
8.15	Mark Index.....	80
8.16	Video Control.....	80
8.17	Audio Control.....	80
8.18	Display Control.....	80
8.19	Registers.....	80
9.	EXTEND TERMINAL CONTROL	82
9.1	Function Assignment	83
9.2	Function User Setting	85
9.3	Controller	89
9.3.1	Simple Circuit	89
9.3.2	Diode Matrix Circuit	90
10.	ADDITIONAL NOTES.....	91
	Appendix A - Complete Command List by Name	92
	Appendix B - Complete Command List by Mnemonic.....	94
	Appendix C - DVD Command List	96
	Appendix D - CD Command List.....	98
	Appendix E - VCD Command List	100
	Appendix F - Error Codes	102
	Appendix G - SPECIFICATIONS OF RS-232 TRANSCEIVER.....	103

1. INTRODUCTION

This document defines the RS-232C command protocol for the Pioneer DVD-V8000 Industrial DVD Player.

The DVD-V8000 is capable of playing DVD, CD and VCD discs. The device has three control methods, front panel, remote control or computer interface through the RS-232C serial port.

This manual addresses the various commands and precautions required when using the Pioneer DVD-V8000 player with a computer. Please refer to the *DVD-V8000 Operating Instructions* for details on operating the unit via the front panel and/or remote control.

Chapter Number	Description
Chapter 2	describes the Interface Connector Specifications and the computer control features of the DVD-V8000
Chapter 3	discusses Baud Rate Settings, Interface Operation, Control Protocol, and Internal Operation via computer
Chapter 4	explains the Player Command Structure in detail
Chapter 5	reviews each command in detail
Chapter 6	defines Address and Player Condition requests
Chapter 7	relates to the various operating modes
Chapter 8	discusses the internal registers
Chapter 9	details the extend terminal control functions

CAUTION: The material in this manual is subject to change without notice.

2. INTERFACE

2.1 Interface Connector

A computer may be connected to the DVD-V8000 using a 15-pin D-Sub connector (e.g., a JAE DALC-J15SAF connector with suitable plug such as the JAE DA-15PF-N) to the RS-232C serial port or to the parallel port.

This unit is also equipped with 9pin connector for serial control.

In advanced setup user can choose which port to be used for serial control depends on the cable availability.

Either 9pin cross cable or conventional 15pin cable(same cable to be used with DVD-V7400) are available.

The factory default setup is 15pin.

The pins are identified below:

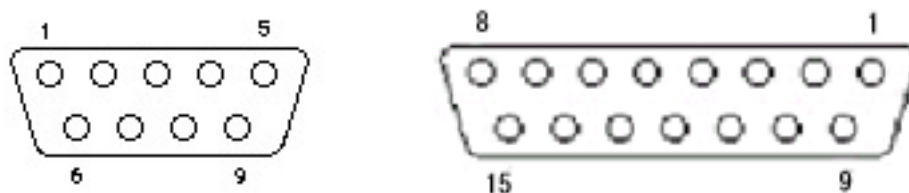

2.2 Serial Interface Pin Specification

15-pin D-Sub connector

Pin #	Terminal	Input/Output	Function
1	GND	--	ground
2	TxD	Output	send data
3	RxD	Input	receive data
4	DTR	Output	data terminal ready
5	POWER	Input	external power control
6	SW1	Input	
7	SW2	Input	
8	SW3	Input	
9	SW4	Input	
10	SW5	Input	
11	SW6	Input	
12	SW7	Input	
13	SW8	Input	
14	DLTST	Input	used only for servicing the unit – do not connect
15	STOP ST	Output	PLAY/STOP status

Refer to the instruction manual about 'STOP ST'.

9-pin D-Sub connector

Pin #	Terminal	Input/Output	Function
1	NC		
2	RxD	Input	receive data
3	TxD	Output	send data
4	DTR	Output	data terminal ready
5	GND	--	ground
6	NC		
7	RTS	Output	CTS is returned to RTS as it is.
8	CTS	Input	
9	NC		

2.3 Computer Control Functions

2.3.1 Serial Control (see Chapters 3, 4, 5 and 6)

The player and computer are based upon the RS-232C protocol and are connected through the TxD, RxD, DTR and GND terminals.

2.3.2 Extend Terminal Control (see Chapter 9)

Control the player with the Extend Terminal Switches (SW#). Even if the Key Lock is set (active), the extend terminal control is available.

2.3.3 External Power Control

Control the player's power with the Power Pin within the Interface Connector.

If the player detects a high signal throughput (100m/sec or more) during the Standby mode, the player powers ON. If the player detects the same signal during the Power ON mode, the player powers OFF and switches to the Standby mode.

The specifications for the Power pin are as follows:

Maximum Input Voltage	Less Than 12V
High Level Signal	More Than 3.3V
Low Level Signal	Less Than 0.5V

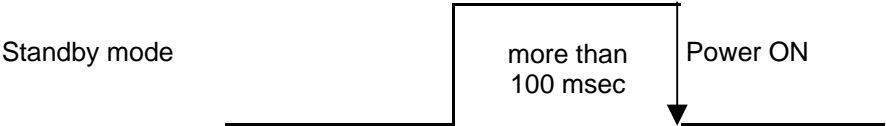

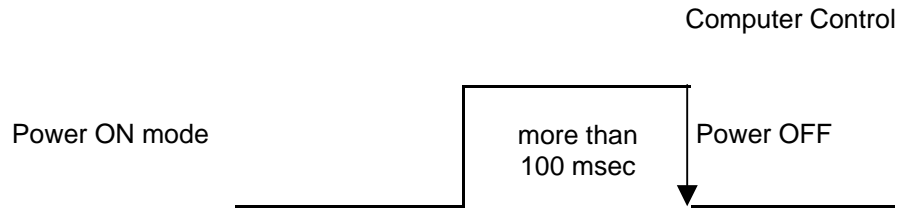

Check the Key Lock condition. If the Key Lock mode is active, the player ignores the control (refer to the Key Lock command description).

Do not operate the POWER pin while the player is switching to Power ON mode and the STANDBY indicator is still amber.

3. SERIAL CONTROL

3.1 Serial Interface Specifications

3.1.1 Signal Interface

The signal interface is a standard RS-232C connection.

3.1.2 Data Type

Data Length: 8 bit

Stop Bit: 1 bit

Parity bit: No Parity

3.1.3 Data Transfer Speed (Baud Rate)

The data transfer speed may be set to either 4800, 9600 or 19200 baud through the Advanced Setup Menu screen or with the Advanced Feature Menu Set command (refer to the DVD-V8000 Operating Instructions for command description).

NOTE: The factory default is 4800 baud; however, the player memorizes the transfer speed each time the power is cycled.

3.2 Communication with a Computer

The DVD-V8000 communicates to the computer through the RS-232C port using pins 2 and 3 for communication and Pin 1 for grounding in case of using 15-pin D-sub connector or Pin 5 for grounding in case of using 9-pin D-sub connector. Control or “handshaking” lines other than the TxD and RxD connections are not required. Please refer to the diagram below for clarification.

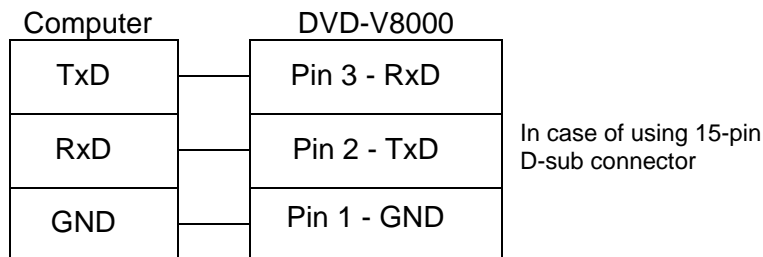

Some computers require the CTS port to be set to HIGH during communication. It is best to connect the CTS and DSR port on the computer to the DTR port on the player. During normal operation the player's DTR is set to HIGH thus the unit is able to receive a command at any time.

3.3 Command and Status

During normal operation, when a computer transmits commands to a DVD-V8000, the player responds with the status message, 'execution complete'.

Example

<u>COMPUTER</u>		<u>DVD-V8000</u>
(1) "Search to Frame 1000"	⇒	(2) Search Execution
	←	(3) Complete
(4) "Play to Frame 2000"	⇒	(5) Play Execution
	←	(6) Complete

NOTE: The length of a command string is limited to 32 characters. Please refer to COMMAND STRUCTURE for additional information.

When using a computer to control the DVD-V8000 player, follow the command protocols listed below:

- ASCII characters are used for actual commands and status response
- Command mnemonic is expressed as two (2) ASCII characters
- Uppercase letters are recommended; however, usually there are no distinctions between the uppercase and lowercase letters
- Some commands require an argument (e.g. Chapter number or speed)
- Use a command as the terminator of an argument

The player executes a command as soon as the carriage return <CR> is received. The <CR> acts as the command line terminator.

Example

```
CH<CR>      : Set Chapter for address mode
10SE<CR>    : Search to Chapter 10
```

The player has a command buffer, which stores a command string of up to 32 characters in length.

Example

```
10SE 20PL<CR> : Search to Chapter 10 then play to 20
```

The command string enters the buffer with the first character and continues sequentially from left to right. When the <CR> is entered, the commands are executed sequentially beginning with the first command in the buffer. In the example above, the first command is 10SE.

NOTE: The player ignores codes in the command string such as <SPACE>

or <LF> (line feed) which have no affect on the player.

NOTE: Some commands, sent after a specialty command which includes an AUTOSTOP setting, (PL, MF, MR, etc.), cause the player to execute the new command before the AUTOSTOP is enacted (see Chapter 5, Command Descriptions).

When all the commands in a string have finished executing, the player transmits or *returns* the "complete" message that is represented by the capital letter **R**.

The player returns an R after a command has been executed. This response is called the Automatic Status. The Automatic Status signals the computer program to send the next command. If this function is not used, the command processing Time must be taken into consideration before the next command is sent.

If an error occurs, the player returns an error message such as E04. The message indicates an error has occurred as well as the type of error. Error messages are in the form of EXX where XX represents a 2-digit error code.

In some cases, an incorrect command sends the player to Search within a non-recorded area and the player returns an error message. Use the Request Status function to determine the unit's current status (actual player hardware failures are rare).

- ?P to determine the Active mode of the player
- ?X, ?M, ?H, ?S to determine the player information, model name, player region code, the setting of Advanced Setup Menu, etc.
- ?F, ?T, ?C, or ?R to determine the current Frame, Time, Chapter, Title/Track number, respectively.
- ?V, ?K, ?G, ?Y, or ?Q to determine the disc information, disc type, total Frame number, TOC information, etc.

The status functions are summarized below:

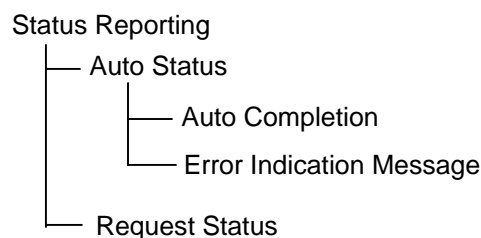

3.4 Error Messages

If an error occurs during a command execution, the player returns an error code. The table below lists each code with a description of the error:

Code	Message	Description
E00	Communication error	<i>Communication Line Error due to framing error or buffer overflow</i>
E04	Feature not available	<i>Non-Usable Function has been tried – either the command mnemonic is wrong or the command can not be used in this mode</i>
E06	Missing argument	<i>Correct parameter is not specified</i>
E11	Disc does not exist	<i>There is no disc in the tray</i>
E12	Search error	<i>Search address is missing</i>
E15	Picture stop	<i>Playback has been stopped by VOBU Still while in the Auto Play mode</i>
E16	Interrupt by other device	<i>The command(s) sent via the serial line were not executed before commands were sent from the front panel buttons and/or remote control</i>
E99	Panic	<i>Unrecoverable Error occurred – possible that a disc cannot be loaded and/or playing does not continue</i>

3.5 Initial Setting

The following table provides the default internal register and switch settings. Take care when setting the required parameters for an application program.

Register/Switch	Setting at Power ON
Video Switch	1 : ON
Audio Switch	3 : Audio 1
Display Switch	0 : OFF
Address mode	1 : Time
Speed Parameter	15 : 1/4 Speed
CCR	3 : Mode 3
Register A	3 : Title/Chapter and Frame Display (DVD) Track/Time Display (CD, VCD)
Register D	0 : CR

4. COMMAND STRUCTURE

The DVD-V8000 supports the commands listed below.

No.	Page	COMMAND		SUPPORTING FORMATS			
		Name	Mnemonic	DVD-Video	DVD-VR	CD	VCD
5.1	P15	Open	OP	X	X	X	X
5.2	P15	Close	CO	X	X	X	X
5.3	P15	Reject	RJ	X	X	X	X
5.4	P16	Start	SA	X	X	X	X
5.5	P17	Play	(adrs) PL	X	X	X	X
5.6	P18	Pause	PA	X	X	X	X
5.7	P18	Still	ST	X	X		X
5.8	P19	Step Forward	SF	X	X		X
5.9	P19	Step Reverse	SR	X	X		
5.10	P20	Scan Forward	NF	X	X	X	X
5.11	P20	Scan Reverse	NR	X	X	X	X
5.12	P20	Scan Stop	NS	X	X	X	X
5.13	P20	Multi-Speed Forward	(adrs) MF	X	X		X
5.14	P20	Multi-Speed Reverse	(adrs) MR	X	X		
5.15	P21	Speed	arg SP	X	X		X
5.16	P22	Search	adrs SE	X	X	X	X
5.17	P23	Search & Play	adrs SL	X	X	X	X
5.18	P24	Stop Marker	adrs SM	X	X	X	X
5.19	P26	Lead Out Symbol	LO	X	X	X	X
5.20	P26	Clear	CL	X	X	X	X
5.21	P27	Frame	FR	X			
5.22	P27	Block Number	BK			X	
5.23	P28	Time	TM	X	X	X	X
5.24	P28	Chapter	CH	X	X		
5.25	P28	Title	TI	X	X		
5.26	P29	Index	IX			X	
5.27	P29	Track	TR			X	X
5.28	P29	Select Subtitle	arg SU	X			
5.29	P30	Select Audio	arg AU	X	X		
5.30	P30	Select Aspect	arg AP	X			
5.31	P30	Select Angle	arg AG	X			
5.32	P31	Select Parental-Level	arg PT	X			
5.33	P31	Audio Control	arg AD	X	X	X	X
5.34	P32	Video Control	arg VD	X	X	X	X
5.35	P33	Display Control	arg DS	X	X	X	X
5.36	P34	Keylock	arg KL	X	X	X	X
5.37	P35	Stack Group Set	arg GP	X	X		
5.38	P35	Command Stack Play	arg BS	X	X		
5.39	P36	Command Stack Data Upload	BU	X	X	X	X
5.40	P39	Command Stack Data Download	BD	X	X	X	X
5.41	P40	Weekly Timer Data Upload	WU	X	X	X	X
5.42	P47	Weekly Timer Data Download	WD	X	X	X	X

Operating Modes

5.43	P48	Output Select	arg OS	X	X	X	X
5.44	P48	DVD VR Play Mode	arg VP	X	X		
5.45	P49	Repeat Mode	arg RM	X		X	X
5.46	P49	General Purpose Parameter	arg >A,>B,,,>Z	X	X	X	X
			arg _A,_B,,,_Z	X	X	X	X
			arg <A,<B,,,<Z	X	X	X	X
5.47	P51	Chapter Skip	arg SK	X	X	X	X
6.1	P52	P-Block Number Request	?A	X	X	X	X
6.2	P52	Title/Track Number Request	?R	X	X	X	X
6.3	P53	Chapter Number Request	?C	X	X		
6.4	P53	Time Code Request	?T	X	X	X	X
6.5	P53	Block Number Request	?B			X	
6.6	P54	Frame Number Request	?F	X			
6.7	P54	Index Number Request	?I			X	
6.8	P55	Total Frame Request	?Y	X	X		
6.9	P55	TOC Information Request	?Q	X	X	X	X
6.10	P56	Disc Region Code Request	?G	X			
6.11	P56	DVD Disc Status Request	?V	X	X		
6.12	P57	CD Disc Status Request	?K			X	X
6.13	P58	Register A Set (Display)	arg RA	X	X	X	X
6.14	P60	Register D Set (TxD Term)	arg RD	X	X	X	X
6.15	P60	Print Character	arg PR	X	X	X	X
6.16	P61	Clear Screen	CS	X	X	X	X
6.17	P61	Real Time Clock Set	WW	X	X	X	X
6.18	P62	Advanced Setup	arg MS	X	X	X	X
6.19	P64	Communication Control Set	arg CM	X	X	X	X
6.20	P64	Player Active Mode Request	?P	X	X	X	X
6.21	P65	Player Model Name Request	?X	X	X	X	X
6.22	P65	Real Time Clock Request	?W	X	X	X	X
6.23	P66	Advanced Setup Request	?S	X	X	X	X
6.24	P66	Player Region Code Request	?H	X	X	X	X
6.25	P67	CCR Mode Request	?M	X	X	X	X
6.26	P67	Input Number Request	?N	X	X	X	X
6.27	P67	Error Code Request	?E	X	X	X	X
6.28	P67	Input Unit Request	?I	X	X	X	X
6.29	P68	Register A Request	\$A	X	X	X	X
6.30	P69	Register D Request	\$D	X	X	X	X
6.31	P69	Menu Call	arg MC	X			
6.32	P70	Numeric Button	arg NB	X			
6.33	P70	Button Select	arg CU	X			
6.34	P71	ENTER Button	(arg) ET	X			
6.35	P72	Get Information	arg GI	X			
6.36	P74	Memory Data Upload	MU	X	X	X	X
6.37	P75	Firmware Version Request	?Z	X	X	X	X

NOTE: arg (argument) or adrs (address) prefaces a command with an argument or address parameter. If the arg or adrs is in parentheses (), the parameter is optional.

4.1 Command Mnemonic

Each command is expressed as two (2) ASCII characters. There is no distinction between uppercase and lowercase letters except when the Character strings are in a PR command.

4.2 Argument

An Argument, expressed in either ASCII characters or ten digits, consists of either an address or an integer. A Control Register uses an integer value to set a specified value or condition.

If a command requires an argument, it is always placed before the command.

Example : $N_1N_2N_3$
 Minimum 000 ~ Maximum 300 (except MS command)
 Minimum 000 ~ Maximum 2047 (Only MS command)

NOTE: If a command requires an argument but one is not supplied, the player returns an error message.

An Address can be a Title, a Chapter, a Track, a Frame Number, or a Time Code depending upon how the address flag is set. The Address must not exceed ten characters and/or digits.

Address Type	Media Type	Format	Range (Min-Max)
Title Number	DVD	N_1N_2	1 ~ 99
Chapter Number	DVD	N_1N_2	1 ~ 99
Frame Number	DVD	$N_1N_2N_3N_4N_5N_6$	1 ~ 999999
Time Code	DVD	$N_1N_2N_3N_4N_5^a$	0 ~ 599:59
	CD/VCD	$N_1N_2N_3N_4^b$	0 ~ 99:59
Track Number	CD/VCD	N_1N_2	1 ~ 99
Block Number	CD	$N_1N_2N_3N_4N_5N_6^c$	0 ~ 995974

4.3 Command String

A command string consists of multiple commands on one line. The maximum length of a command string is 32 characters. All command strings are terminated by the Carriage Return <CR> code (0DH hex).

Example : FR2000SE 2300PL<CR>

NOTE: Assign the following commands individually.

^a $N_1N_2N_3$ minutes N_4N_5 seconds.

^b N_1N_2 minutes N_3N_4 seconds.

^c N_1N_2 minutes N_3N_4 seconds N_5N_6 Block.

- Print Character [PR]
- Stack Data Upload [BU]
- Stack Data Download [BD]
- Memory Data Upload [MU]

Once the <CR> termination command is added to the string, the command string is executed from left to right in sequential order.

If an error occurs during the execution of a String, the remainder of the string following that command is ignored.

If a new command string is input before the current string executes completely, the current string is aborted and the remaining commands are cleared.

To cancel an executing string, send the termination command <CR> alone.

If a new command without [?*], [#*] or [\$*] is input while playing the current command stack, the remaining commands are cleared.

The DVD-V8000 does not accept other commands during the execution of a Search command, returning an E04 error message. After issuing a Search command, wait until the Return (R) status appears before issuing another command. An exception to this rule is the Mark Frame Play command (i.e. FR1200PL), when it is unnecessary to wait for the R status before sending additional commands.

4.4 Status Returns

The completion message used in the Automatic Status is **R**.

Example: R<CR>

4.5 Error Message

An error message consists of an **E** followed by a two-character error code.

Example: EN₁N₂<CR>

The error message occurs when the given command cannot be processed.

4.6 Request Status Return

In response to a single request command, the status returns as a line of letters terminated by <CR>.

If multiple commands are sent within the same String, the player returns a separate status value upon completion of each command. A status value is a character string with a <CR> termination code.

Example: ?C?F<CR> ⇒ 02<CR>
 10260<CR>

When the command is at the end of the command string, the **R** within the completion message is omitted.

Example: ST?F<CR> ⇒ 23005<CR> (completion omitted)

Example: ?FST<CR> ⇒ 23005<CR>R<CR> (not omitted)

4.7 Timing

A player needs a brief period after receiving a command before returning a Status Value or “R <CR>”. It is defined as follows:

T1 represents the time between the termination of the command string <CR> received and the beginning of the command execution. It is approximately 35ms maximum.

T2 represents the time for executing the command, depending upon the command type and the player’s condition. In case of a status request command such as “?F”, T2 requires less than 1ms.

T3 represents the time that is needed for transferring data (TxD) per byte. It requires a maximum of 6ms per byte. In case of the return data for “?F” request, a player is supposed to be back 8 bytes data, that is composed of 7 digit Frame number and “<CR>”. In this case the transfer time of each byte is not exactly the same with 6ms, it takes usually around 10ms for transferring 8 bytes data total, and it is supposed to take less than 20ms.

Example:

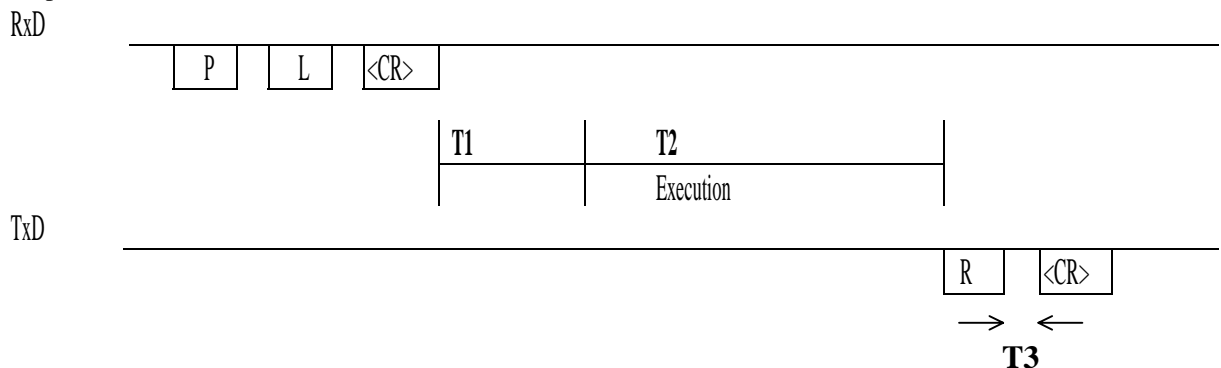

4.8 Start Timing Under Synchronized Playback (with several players)

To synchronize each playback to External Reference Sync Signal among several players, issue the PL command after all players have finished the Search. The next chart indicates the when to issue the PL command.

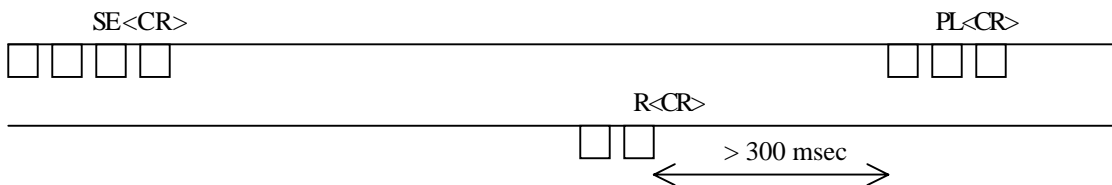

When the player executes a Search (SE command) and it returns a completion message, there is a brief period when the player ignores a PL command. Issue a PL command at least 300ms after the command completion.

After issuing a PL command, there may be a brief period before synchronized playback starts. If all players receive a PL command after a Search but before the PLAY command is issued (see following example), then playback is synchronized after a pause of approximately four fields which is less than one Frame in length.

When the player receives a PL command during the Unspecified Area (see below), the playback might start at the timing A field, or it might start at the timing B. Thus, this playback location is called an Unspecified Area.

Only the PL command under external synchronization, is executed during the V sync timing.

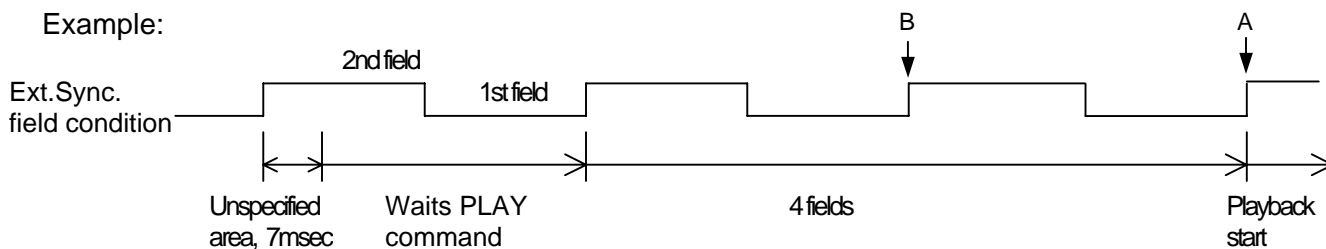

The video output under external synchronization delays for one field to the black burst signal input to EXT SYNC IN terminal. In the above figure, the field of black burst at the playback start timing is second field, but the field of the video output from DVD-V8000 is first field.

5. COMMAND DESCRIPTIONS

5.1 Open

Function : Door Opens (Tray Ejects)

Format : OP

Explanation : If the command is sent while the player is in the Park mode, the tray ejects and the player enters the Open mode. After the tray is ejected, the player returns a completed status message.

If the player is in any mode other than Open or Park, the disc stops, the player enters Open mode and the door opens.

If the player is already in Open mode, an error message is returned.

Execution:

String	Status Return	DVD player
OP<CR>	R<CR>	Park mode to Open mode

5.2 Close

Function : Door closes (Tray closes)

Format : CO

Explanation : If the command is sent while the player door is open, the door closes then the player enters the Park mode. After the door closes, the player returns the completed status message.

If the player is in any mode other than Open or if the player door is already closed, an error message is returned.

Execution :

String	Status Return	DVD player
CO<CR>	R<CR>	Open mode to Park mode

5.3 Reject

Function : Disc rotation stops

Format : RJ

Explanation : If the command is sent while the player is in Random Access mode or Setup mode, the player enters Reject mode and the disc stops

rotating. Once the disc completely stops, the player enters Park mode and returns the completed status message.

If the command is sent while the player is in Park mode, the player enters the Open mode and the tray extends.

Execution :

String	Status Return	DVD player
RJ<CR>	R<CR>	Random Access mode to Park mode

NOTE: Sending a second Eject command causes the player to open the tray.

5.3.1 Reject

Function : Disc rotation stops

Format : 99RJ

Explanation : If the command is sent while the player is in Random Access mode or Setup mode, the player enters Reject mode and the disc stops rotating. Once the disc completely stops, the player enters Park mode and returns the completed status message.

If the command is sent while the player is in Park mode, the player returns the completed status message immediately without entering Open mode.

5.4 Start

Function : Disc rotation starts

Format : SA

Explanation : If the command is sent while the player is in Open, Park or Reject mode, the player immediately enters Setup mode and the disc begins spinning up. The player is ready for playback when the device reaches the beginning of the program (DVD, CD or VCD disc pauses or stills at the first Track). The player returns the completed status when the disc pauses or stills.

If the player receives the command while playing a menu, the player returns an error message. However, if the disc program does not allow new commands once playback begins, the player ignores the command.

Execution :

String	Status Return	DVD player
SA<CR>	R<CR>	Park mode to Pause mode
SA<CR>	E11<CR>	Open mode to Park mode <i>Error – No disc in tray</i>

5.5 Play

Function : Pictures and sound are reproduced (Option - Auto Stop)

Format : (Address)PL

Explanation : If the command is sent while the player is in Open mode, a DVD disc plays according to the menu selection or from the first Title if a menu is absent. If the command is sent while the player is in Park, or Reject mode, a DVD disc plays from the first Title. A CD/VCD disc plays from the first Track. The player returns the completed status message after playback begins.

If the player is in Random Access mode when the Play command is sent, the player enters Play mode and returns the completed status message. The Play is the only mode in which audio plays back simultaneously with video.

If an address is specified, an Auto Stop occurs on the selected sequence. The specified address is written as a Mark Frame or Mark Time and is compared with the current address. If the current address matches the specified address, the player enters Still mode and returns the completed status message.

If the Frame count difference is less than 24 Frames between the present Frame and the specified Frame, the player returns an E06 error message and the marker is not set.

The Auto Stop command is canceled if another command is sent before the player reaches the specified address. When this occurs, the player enters normal Play mode (the Stop Marker command is similar in function to Auto Stop).

If a VOB Still is detected before the player reaches the specified address, the player enters Still mode and returns an error message. However, if the disc program does not allow a stop, the player ignores the command and it returns an error message.

The available address modes are listed below:

Address Mode	DVD Video	DVD VR	CD	VCD
FR (Frame)	X			
TM (Time)	X	X	X	X
CH (Chapter)	X	X		
TI (Title)	X	X		
BK(Block)			X	
IX(Index)			X	
TR (Track)			X	X

Execution :

String	Status Return	DVD player
PL<CR>	R<CR>	Park mode to Play mode
TM0325PL<CR>	<i>plays to 3 minutes 25 seconds</i>	Pause mode to Play mode
	R<CR>	Play mode to Still mode

Special case : When address mode is chapter and the address is followed by - (hyphen) during playing DVD Video, player makes special behavior.

For example, when the command CH5-PL is executed, the player enters still mode 2 or 3 frames before entering chapter 5.

5.6 Pause

Function : Playback ceases temporarily

Format : PA

Explanation : If the command is sent while the player is in Random Access mode, the pause occurs at the current disc location. The player returns the completed status message immediately.

In Pause mode, Still and Video Squelch are ACTIVE. However, if the disc program does not allow a pause, the player ignores the command and returns an error message (E04).

Execution :

String	Status Return	DVD player
PA<CR>	R<CR>	Play mode to Pause mode
PL<CR>	R<CR>	Return to Play mode

5.7 Still (DVD, VCD)

Function : Playback is stopped on a selected visual

Format : ST

Explanation : If the command is sent while the player is in Random Access mode, playback stops at the current disc position and the player enters Still mode. The player returns the completed status message immediately. However, if the disc program does not allow a pause, the player ignores the command and returns an error message (E04).

Execution :

String	Status Return	DVD player
ST<CR>	R<CR>	Play mode to Still mode
PL<CR>	R<CR>	Return to Play mode

5.8 Step Forward (DVD, VCD)

5.9 Step Reverse (DVD)

Function : Playback is moved forward or in reverse by one Frame

Format : SF (Step Forward)

SR (Step Reverse)

Explanation : If the command is sent while the player is in Random Access mode, the picture moves one Frame forward or one Frame in reverse. After the move is accomplished, the player enters Still mode and returns the completed status message.

If the disc program does not allow a pause, the player ignores the command and returns an error message (E04).

NOTE: A Video CD disc does not support the Step Reverse command

Execution :

String	Status Return	DVD player
SF<CR>	R<CR>	Still mode Moves 1 Frame forward
SRSRSR<CR>	R<CR>	Still mode Moves 3 Frames backwards
		Still mode

5.10 Scan Forward**5.11 Scan Reverse****5.12 Scan Stop**

Function : Playback moves quickly forward or in reverse

Format : NF (Quick Forward scanning of the disc)

NR (Quick Reverse scanning of the disc)

NS (Stop Quick Forward/Reverse scanning and return to normal playback)

Explanation : If the command is sent while the player is in Random Access mode, the screen proceeds forward (NF) or in reverse (NR) quickly. When scanning is finished, the player resumes the Random Access mode and returns the completed status message.

If the SCAN command is sent while the player is in Fast Forward or Reverse Playback, the player enters Scan mode.

Once the NS command is sent, the player resets to the normal Playback mode and returns the completed status message.

Execution :

String	Status Return	DVD player
NF<CR> or NR<CR>	R<CR>	Play mode to Scan mode
NS<CR>	R<CR>	Return to Play mode

5.13 Multi-Speed Forward (DVD, VCD)**5.14 Multi-Speed Reverse (DVD)**

Function : Playback occurs at the speed specified in the Speed Register
(Option - Auto Stop)

Format : (Address)MF (Multi-Speed Forward)

(Address)MR (Multi-Speed Reverse) (Address > 0)

Explanation : If the player is in Random Access mode when the command is executed, the player enters Multi-Speed mode and returns the completed status message immediately.

While in Multi-Speed mode, pictures are reproduced at the speed specified by the Speed Register. No audio tracks are played during Multi-Speed playback.

NOTE: These speeds are approximate values only.

If an address is specified, an Auto Stop occurs on the selected sequence. The specified address is written as a Mark Frame or Mark Time and is compared with the current address. If the current address matches the specified address, the player enters Pause or Still mode and returns the completed status message. This command functions in a similar manner as the Stop Marker command.

If another command is issued before the player reaches the specified Address, the Auto Stop command is canceled and the player enters normal Multi-Speed mode. However, if the disc program does not allow a pause, the player ignores the command.

NOTE: DVD offers only fixed speed reverse.

VCD offers 1/2 to 1/16 speed forward only. Sometimes, depending on its forward speed, VCD Multi-Speed Forward may finish several frames earlier than the target address because playback does not rely on Frame counts.

Sometimes an Auto Stop command within a Multi-Speed command misses the specific address. Depending upon when the command is sent, a playback address may be missed by a maximum of ten-Blocks.

The available address modes in each disc type are listed below:

Address Mode	DVD Video	DVD VR	CD	VCD
FR (Frame)	X			
TM (Time)	X	X		X
CH (Chapter)	X	X		
TI (Title)				
TR (Track)				X

Execution :

String	Status Return	DVD player
MF<CR>	R<CR>	Play to Multi-Speed mode
TM0325MF<CR>		Play to 3 min. 25 sec with Multi-Speed mode
	R<CR>	Still mode

5.15 Speed (DVD, VCD)

Function : Specifies the speed for Multi-Speed playback

Format : Integer SP

Explanation : The command rewrites the contents of the Speed Register and returns the completed status message. The current mode of the player remains the same.

The speed parameter indicates the number of fields per second. The range is 0 through 90 with a default value of 15. The relationship between the integer, speed parameter and the actual speed of the player is as follows:

Integer	Speed Parameter	Speed
60	46~90	1/1
30	23~45	1/2
15	12~22	1/4
7	6~11	1/8
4	3~5	1/16
1	0~2	STEP1

NOTE: When 'REV STEP/REV PLAY' is set to 'Resolution' in ADV.SETUP, DVD only offers fixed reverse speeds which varies from about 1/8 to about 1/16 depending on the transfer rate.

NOTE: VCD only offers 1/2 to 1/16 forward speeds. Reverse speed is not available for VCD. Speeds are approximate values only.

Execution :

String	Status Return	DVD player
4SPMF<CR>	R<CR>	Play mode to $1/16$ speed forward
30SP<CR>	R<CR>	Multi-Speed to $1/2$ Multi-Speed
4SPMR<CR>	R<CR>	Slow speed reverse

5.16 Search

Function : Search to specified address

Format : Address SE

Explanation : The specified address is written into the Search Register in accordance with the current Search address mode.

When the Search command is sent to the player, the specified address is compared with the current address. The pick-up is moved so that the difference becomes 0.

Upon reaching the specified address, the player enters the Pause mode for a CD or the Still mode for other disc types. The player then returns the completed status message. If the player misses the specified address or can not find it, an error message (E06 or E12) is returned. However, if the disc program disallows a Time, Chapter or Title Search, the player ignores the

command and an error message (E04) is returned. In addition, if the disc program blocks the Pause command, the player ignores the command.

The DVD-V8000 does not accept other commands during the execution of a Search command, returning an E04 error message. After issuing a Search command, wait until the Return (R) status appears before issuing another command. An exception to this rule is the Mark Frame Play command (i.e. FR1200PL), when it is unnecessary to wait for the R status before sending additional commands.

The available address modes are listed below:

Address Mode	DVD Video	DVD VR	CD	VCD
FR (Frame)	X			
TM (Time)	X	X	X	X
CH (Chapter)	X	X		
TI (Title)	X	X		
BK(Block)			X	
IX(Index)			X	
TR (Track)			X	X

Execution :

String	Status Return	DVD player
FR4500SE<CR>	R<CR>	Play mode Search to Frame 4500 Still mode (DVD)
CH5SE<CR>	R<CR>	Play mode Search to Chapter 5 Still mode
TR2SE<CR>	R<CR>	Play mode Searches to Track 2 Still mode (VCD)

5.17 Search & Play

Function : Searches to specified address and starts to play immediately

Format : Address SL

Explanation : The specified address is written into an appropriate register according to the Address. The player then compares the address with the current address. The pick-up moves so that the difference becomes 0.

The player plays a disc immediately after reaching the specific address. In case the player misses or fails to locate the address, it returns an error code (E06 or E12). If Frame is selected in Address Mode, the player ignores the command.

The available address modes are listed below:

Address Mode	DVD Video	DVD VR	CD	VCD
FR (Frame)				
TM (Time)	X	X	X	X
CH (Chapter)	X	X		
TI (Title)	X	X		
BK(Block)			X	
IX(Index)			X	
TR (Track)			X	X

Execution :

String	Status Return	DVD player
CH5SL<CR>		Play mode
	R<CR>	<i>Search Chapter 5 and Play</i>
TR2SL<CR>		
	R<CR>	<i>Search Track 2 and Play</i>

5.18 Stop Marker

Function : Stop Marker is set to the specified address

Format : Address SM

Explanation : The specified address is written into the Mark-Frame Register or Mark-Chapter Register in accordance with the address specification flag. The player returns the completed status message immediately.

The Stop Marker is cleared when the player reaches the marked address via a Play command, a Multi-Speed operation or other action. The player enters the Pause mode (CD) or the Still mode (other disc types) with no messages returned. However, if the disc program does not allow a pause, the player ignores the command.

If the Frame count difference is less than 24 Frames between the present Frame and the stop marker address, the player returns an E06 error message and the marker is not set.

A Time Code or Chapter Number request notes if the player reaches the marked address. The Clear and Reject commands remove the marker.

The Stop Marker is the same in functionality as the Play (or Multi-Speed) Auto Stop commands. The primary difference is when the player return a status message. The Auto Stop command returns the completed status message when the player reaches the marked address. The Stop Marker command returns the message as soon as the Stop Marker is set.

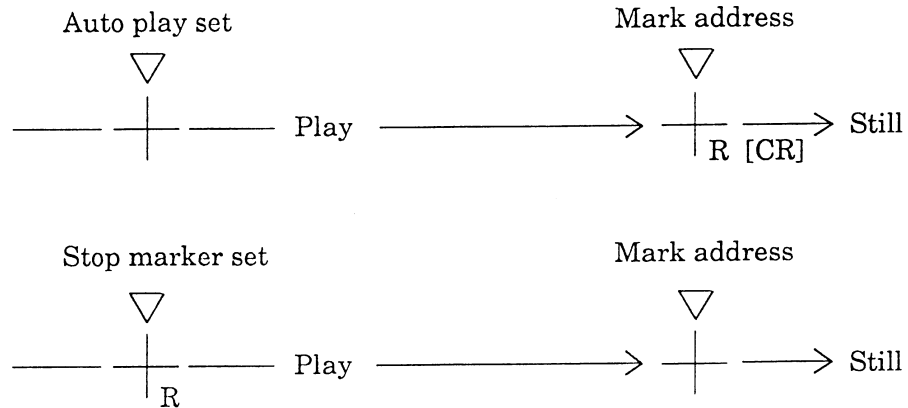

The available address modes are listed below:

Address Mode	DVD Video	DVD VR	CD	VCD
FR (Frame)	X			
TM (Time)	X	X	X	X
CH (Chapter)	X	X		
TI (Title)	X	X		
BK(Block)			X	
IX(Index)			X	
TR (Track)			X	X

Execution :

String	Status Return	DVD player
TM0325SMPL<CR>	R<CR>	Pause mode to Play mode
MF<CR>	R<CR>	Multi-Speed mode
PL<CR>	R<CR>	Play mode <i>plays to 3 minutes 25 seconds</i> ⇒ <i>Still mode</i>

Special case : When address mode is chapter and the address is followed by - (hyphen) during playing DVD Video, player makes special behavior. Refer to the page of PL command for detail.

5.19 Lead-Out Symbol

Function : Lead-Out is set for an address

Format : LO Command <CR>

Explanation : This symbol can be used in place of a Time Code or a Frame number as a target address for the Search or Auto Stop functions.

If the player has read the Table of Contents (TOC) from a disc, the Lead-Out Address or Frame Number can be translated into the lead-out Time.

The Lead-Out Search command on a CD or VCD disc stops the player at the end of a program area prior to the read-out area while the Lead-Out Search command on a DVD disc stops the player at the end of this Title.

NOTE: On a VCD disc, the Search address is set several seconds prior to the lead-out point because the Lead-Out command requires the player to read video data in advance.

Execution :

String	Status Return	DVD player
LOSE<CR>	R<CR>	Search to Still mode
?T<CR>	13642<CR>	<i>Time code in program end area</i>
LOPL<CR>	R<CR>	<i>Continue playing to lead-out and then return R<CR></i>

5.20 Clear

Function : Clears the digit buffer or mode

Format : CL

Explanation : The command clears the digit buffer content (input value) and returns the completed status message immediately.

The command releases the Auto Stop or the Stop Marker modes and returns the completed status message immediately. After the commands are released, the player begins normal playback. But the command does not release the Multi Speed command.

The Clear command releases the Repeat mode and erases the Command Stack selections.

Execution :

String	Status Return	DVD player
FR22000CL2300SE<CR>	R<CR>	Play mode searches to Frame 2300 Still mode
TM500SMPL<CR>	R<CR>	Play with Stop Marker
CL<CR>	R<CR>	Stop Marker is released and player begins normal playback

5.21 Frame (DVD)

Function : Address specification flag is set to Frame

Format : FR

Explanation : Address assignment proceeds Frame by Frame. All subsequent addresses are handled as a Frame number.

NOTE: The player returns E04 when playing Video Recording format DVD.

Execution :

String	Status Return	DVD player
FR123450SE<CR>	searches to Frame 123450 R<CR>	Play to Search mode Still mode

5.22 Block Number (CD)

Function : Address specification flag is set to Block

Format : BK

Explanation : Address assignment proceeds by Block. All subsequent addresses are handled as a Block number.

1 second consists of 75 Blocks.

The player is unable to Search to a Block Number on VCD disc.

Execution :

String	Status Return	DVD player
BK243020SE<CR>	searches to 24 min, 30 sec, 20 Blocks R<CR>	Play to Search mode Pause mode

5.23 Time (excludes discs without Time Codes)

Function : Address specification flag is set to Time

Format : TM

Explanation : Address assignment proceeds by Time Code. All subsequent addresses are handled as a Time Code.

(please refer to section 8.10 Serial Use Address Flag)

Execution :

String	Status Return	DVD player
TM12345SE<CR>	<i>Search to 123 min, 45 sec</i>	Play to Search mode
	R<CR>	Still mode

[maximum number for time is 5-digits in length (99959)]

5.24 Chapter (DVD)

Function : Address flag is set to Chapter

Format : CH

Explanation : Address assignment proceeds by Chapter number. All subsequent addresses are handled as a Chapter number. If the Chapter number is not recorded on the disc, an error message is returned.

(please refer to section 8.10 Serial Use Address Flag)

Execution :

String	Status Return	DVD player
CH23SE<CR>	<i>Search to Chapter 23</i>	Play to Search mode
	R<CR>	Still mode

5.25 Title (DVD)

Function : Address flag is set to Title

Format : TI

Explanation : Address assignment proceeds by Title. All subsequent addresses are handled as a Title number.

(please refer to section 8.10 Serial Use Address Flag)

Execution :

String	Status Return	DVD player
TI5SE<CR>	<i>Search to Title 5</i> R<CR>	Play to Search mode Still mode

5.26 Index (CD)

Function : Address flag is set to Index

Format : IX

Explanation : Address assignment proceeds by Index. All subsequent addresses are handled as an Index number.

(please refer to 8.10 Serial Use Address Flag)

Execution :

String	Status Return	DVD player
IX1204SE<CR>	<i>Search to Index 4, Track 12</i> R<CR>	Play to Search mode Pause mode (CD)

5.27 TRACK (CD, VCD)

Function : Address flag is set to Track

Format : TR

Explanation : Address assignment proceeds by Track. All subsequent addresses are handled as a Track number.

(please refer to section 8.10 Serial Use Address Flag)

Execution :

String	Status Return	DVD player
TR15SE<CR>	<i>Search to Track 15</i> R<CR>	Play to Search mode Pause mode

5.28 Select Subtitle (DVD)

Function : Set Subtitle

Format : Integer SU

Explanation : The command sets the Subtitle (caption). The player allows up to 32 subtitles for playback. If an unavailable number is selected, the player returns an E06 error message.

Execution :

String	Status Return	DVD player
		Play mode
0SU<CR>	R<CR>	Subtitle off

5.29 Select Audio (DVD)

Function : Select Audio

Format : Integer AU

Explanation : The command selects the audio channel (Audio Track). The player allows up to 8 audio channels for playback. If an unavailable number is selected, the player returns an E06 error message.

NOTE: If the setting is 0, the Audio Mute is ON.

Execution :

String	Status Return	DVD player
		Play mode
0AU<CR>	R<CR>	Audio Mute ON

5.30 Select Aspect (DVD)

Format : Select Aspect Ratio

Function : Integer AP

Explanation : The command sets the Aspect Ratio for playback. The three ratios are Pan & Scan, Letter Box or Wide. If a disc does not offer video output options, the player returns an E04 error message.

Argument	Aspect Ratio (Video output)
1	Pan & Scan
2	Letter Box
3	Wide

5.31 Select Angle (DVD)

Function : Select Angle

Format : Integer AG

Explanation : The command selects a viewing angle. The player allows up to 9 angles (1AG through 9AG) for playback. If an unavailable angle is selected, the player returns an error message (E04 or E06).

Execution :

String	Status Return	DVD player
1AG<CR>	R<CR>	Play mode Angle is changed

5.32 Select Parental-Level (DVD)

Function : Set Parental Level

Format : Integer PT

Explanation : The command sets the parental level. The player allows up to 8 levels for playback. If an unavailable level is selected, the player returns an error message.

Note: The player accepts this command only when playing a DVD disc.

5.33 Audio Control (DVD, CD, VCD)

Function : Control Audio Output

Format : Integer AD

Explanation : The command allows changes to the audio output from the default value then returns the completed status message. The player resets to the default value when the tray opens or when the power cycles.

NOTE: The player automatically resets the audio control to 3 (Audio 1), when it is powered ON. And the player resets the audio control to 7 when CD or VCD is loaded.

The output channel assignment for each integer (argument) is listed below:

Argument	DVD	CD ¹	VCD
0	Off	Off	Off
1	Audio 2	---	---
2	Audio 3	---	---
3	Audio 1	---	---
4	Off	Off	Off
5	Audio 5	L	L
6	Audio 6	R	R
7	Audio 4	Stereo	Stereo

When playing DVD VR with bilingual audio, the output channel assignment for each integer (argument) is listed below:

Argument	DVD VR with bilingual
0	Off
1	---
2	---
3	---
4	Off
5	Main
6	Sub
7	Main + Sub

Execution :

String	Status Return	DVD player
5AD<CR>	R<CR>	audio output = Stereo becomes audio output = Audio 5, L-ch

5.34 Video Control

Function : Video switch is turned ON / OFF

Format : Integer VD

Explanation : The command switches the video output ON or OFF then returns the completed status message. The default is 1 (video ON).

The squelch switch adjusts the video output when the video control is ON (during playback). If the player is in Park or Pause mode, the video output is OFF and the color background is displayed.

When the Video Control is set to 0 (OFF), the video is squelched at all times.

Argument	Function	Video Switch
0	OFF	OFF
1	ON	ON

Execution :

String	Status Return	DVD player
0VD<CR>	R<CR>	Video Switch = ON Video Switch = OFF

5.35 Display Control

Function : Character display is turned ON / OFF

Format : Integer DS

Explanation : The player rewrites the Display Control Register (argument) then returns the completed status message. The default register value is 0 (display switched OFF). Arguments can display User's Area Characters, Title Number, Time Code, Chapter Number and Audio Output information.

Display changes are restricted when Argument 1 is set through the serial connection. The remote control is blocked from changing the on-screen display.

NOTE: The displayed Frame number attempts to auto-correct to the actual Frame number, however, Frames continue to advance during playback.

Argument	Function
0	OFF
1	Displays user's area that is set by Register A
2	When playing DVD: Title, Number of total Title, play time Remain time and total time based on each Title Audio, Subtitle, Angle When playing CD/VCD: Track, Number of total Track, play time Remain time and total time based on each Title
3	When playing DVD: Chapter, Number of total Chapter, play time Remain time and total time based on each Chapter Transfer rate When playing CD/VCD: Play time, remain time and total time based on Disc

Execution :

String	Status Return	DVD player
1DS<CR>	R<CR>	Display Switch = OFF to Display Switch = ON <i>Display condition is set on Register A</i>
3DS<CR>	R<CR>	Display condition = 3
0DS<CR>	R<CR>	Display Switch = OFF

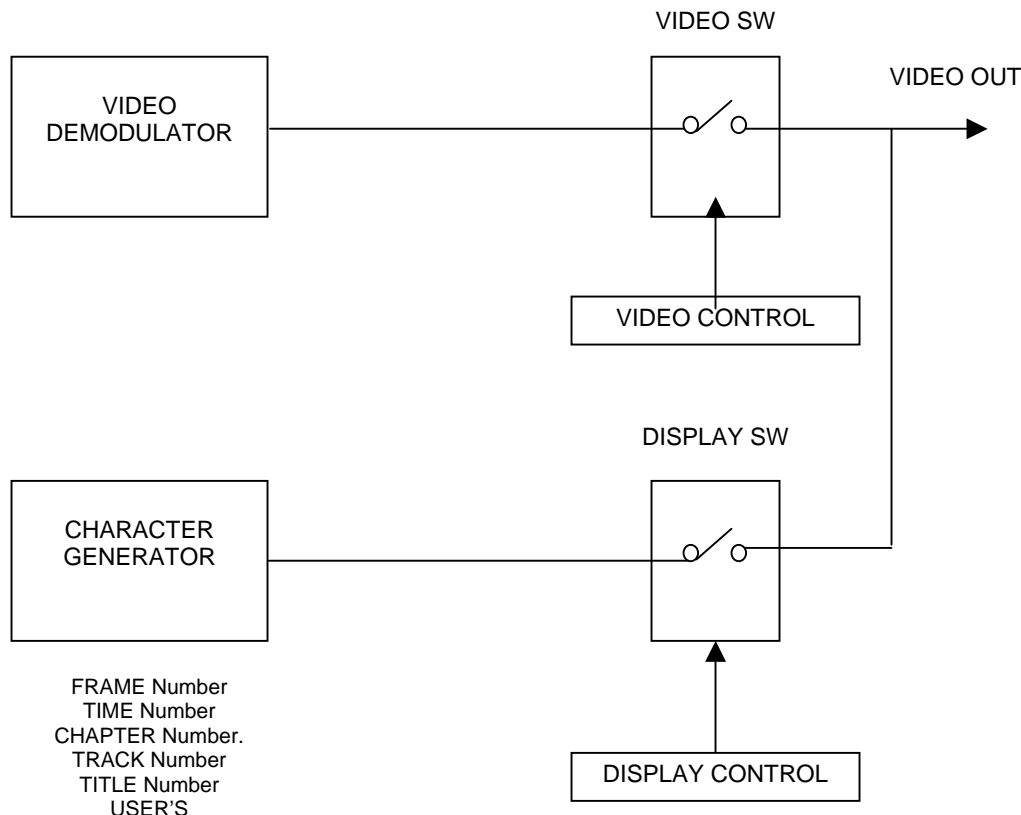

5.36 Key Lock

Function : The key lock switches ON / OFF

Format : Integer KL

Explanation : The command enables/disables the remote control and access through the front panel. LCD button and the keys of EXTEND TERMINAL can't be disabled by this command.

Integer is 1 digit or 5 digits.

In case of 1 digit :

If the key lock switch is set to 1, all buttons (front panel and remote control) including the power control are disabled and REMOTE CONTROL and FRONT KEY in ADV.SETUP are set to Disable. Use this setting for a PC-controlled player to lessen interference from outside sources such as remote controls.

If the key lock switch is set to 2, only the tray open button/key is disabled and the OP command no longer controls the tray. And the setting of TRY in ADV.SETUP is set to Disable. Thus, after powering OFF the player, the locked tray protects the disc from unauthorized personnel.

Argument	Function
0	Unlock
1	Locks all keys include power
2	Locks only tray open

Execution :

String	Status Return	DVD player
1KL<CR>	R<CR>	Key Lock ON
OKL<CR>	R<CR>	Key Lock OFF (unlocked)
2KL<CR>	R<CR>	Tray Open Lock ON

In case of 5 digits : Format 1C₁C₂C₃C₄KL

C ₁ Tray Lock	1:ON 0:OFF
C ₂ PASS THROUGH-MONITOR key Lock	1:ON 0:OFF
C ₃ PASS THROUGH-VIDEO key Lock	1:ON 0:OFF
C ₄ PASS THROUGH -AUDIO key Lock	1:ON 0:OFF

Other keys are unlocked.

The default setting of PASS THROUGH key lock is OFF.

5.37 Stack Group Set (DVD)

Function : Set the Command Stack Group

Format : Integer GP

Explanation : The command sets the stack group for execution or access. It is added in conjunction with the [BS] (COMMAND STACK PLAY) command.

1 to 300, decimal system integer number is used in the argument.

5.38 Command Stack Play (DVD)

Function : Execute Command Stack

Format : Integer BS

Explanation : The command executes the Command stack group after specifying the group number with the GP command.

The player returns an E06 error message if the BS command is issued with an unknown or unspecified group/step number.

1 to 300, decimal system integer number is used in the argument.

Execution :

String	Status Return	DVD player
25GP16BS<CR>	R<CR>	Execute from group 25/step 16

5.39 Stack Data Upload

Function : Reads the data in the player: Command Stack data

Format : BU

Explanation : The player, while in Park mode, sends the data to the computer after sending the command.

The Communication flows as shown below.

(N=9320)

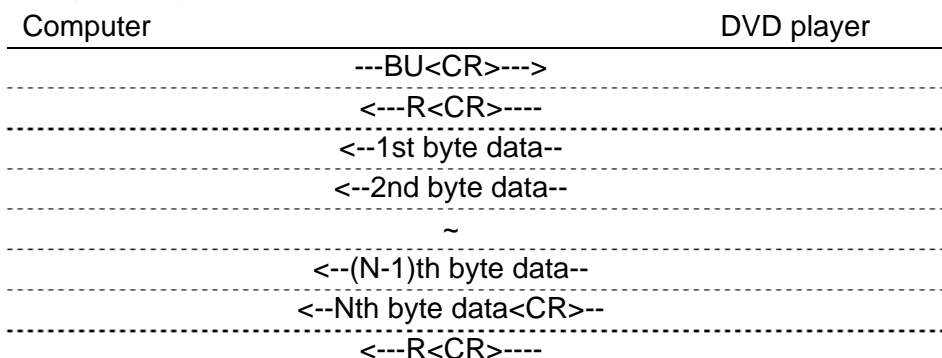

Format of the data:

BP	Contents	Numbers of bytes
0 - 1	(1) Total number of the transfer data (fixed number = 2468H)	2 bytes
2 - 3	(2) The version of this data format (fixed value)	2 bytes
4 - 5	(3) Command #1 Search Pointer	2 bytes
6 - 7	Command #2 Search Pointer	2 bytes
~	~	~
600 - 601	Command #299 Search Pointer	2 bytes
602 - 603	Command #300 Search Pointer	2 bytes
604 - 605	(4) Number of Next Command Data	2 bytes
606 - 607	(5) Number of Next Command Group	2 bytes
608 - 1207	(6) fixed data ffH	600 bytes
1208 - 1213	(7) fixed data ffH	6 bytes

1214 - 1215	(8) Next Data Address	2 bytes
1216 - 9315	(9) Command Stack Data	8100 bytes
9316 - 9319	(10) Checksum	4 bytes

(1) Fixed data:

indicates the total data bytes of this transfer with HEX digits

2468H = 9320

(2) Fixed data:

indicates the version of this data format is (0200H) now

To avoid errors, this code must remain intact. Do not change any digits within this code.

(3)

indicates the head address of the #Nth Command Stack data

The head address is a relative address. The base address is (BP = 1216) and (BP = 1216) is the head byte of the Command Stack Data in this format.

(N = 1 ~ 300)

If the data of #Nth is invalid, it shows (ffffH).

(4)

indicates the numbers of the registered Command Stacks

It is available from 0 to 299 in a HEX digit format.

(5)

indicates the group number of the next Command Stack

It is available from 0 to 299 in a HEX digit format.

(6) Fixed data:

(7) Fixed data:

(8)

indicates the head address of the next Command Stack data

The head address is a relative address. The base address is (BP = 1216) and (BP = 1216) is the head byte of the Command Stack Data in this format.

(9)

Comprises the body of the data

(10)

checksum of the data that indicates the result of adding up BP 0 through BP 9315 and shows in HEX (double word) format

Format of Command Stack data in the data:

The length of Command Stack data is 16 bytes. This is a fixed length. Each byte is made up of aH (upper nibble) and one digit of the command (lower

nibble). The command length is available up to 16 digits. If the command length is less than 16 digits, it fills with (00H).

Example:

Segment Play Command : Title 02, from Frame 3600 to Frame 4800
> 4020036000048007

BP	Data	Explanations
1216 + COMMAND_SRP #n	a4H	
+ 1	a0H	
+ 2	a2H	
+ 3	a0H	
+ 4	a0H	
+ 5	a3H	
+ 6	a6H	
+ 7	a0H	
+ 8	a0H	
+ 9	a0H	
+ 10	a0H	
+ 11	a4H	
+ 12	a8H	
+ 13	a0H	
+ 14	a0H	
+ 15	a7H	

*COMMAND_SRP #n : Command #n Search Pointer

Outline of command : Command has these formats as follows.

DVD 4 digits command (sets the player, the video and the audio control)

DVD 6 digits command (sets the attribute control)

DVD 10 digits command (Chapter Search Command)

DVD 12-digit command (Chapter Segment Play)

DVD 14-digit command (Frame Search)

DVD 16-digit command (Segment Play)

The following four command functions in Command Stack are not regulated in Barcode Format. These commands are regulated as follows.

- 1) End of Group mark: The first byte is (ffH), the others are (00H)
- 2) REPEAT: (49a3H)
- 3) WAIT: (4bxxxxH)
- 4) GOTO: (4axxxxH)

- 5) PASS THROUGH KEY Disable - 4c17H
 Enable – 4c06H
- 6) PASS THROUGH 4cxxxxH

*Refer to the Barcode Format

Execution :

String	Status Return	DVD player
BU<CR>		Park mode
	R<CR>	Receives the command and
	20e40010....02	starts the transfer of the data,
	6743<CR>	9320 bytes (ends with <CR>)
	R<CR>	

5.40 Stack Data Download

Function : Sends the following data to the player; Command Stack data

Format : BD

Explanation : The computer sends Command Stack data to the Parked player if a disc is in the tray.

Refer to the descriptions of Command Stack Data Upload.

The Communication flows as follows.

(N=9320)

Computer	DVD player
	---BD<CR>--->
	<---R<CR>----
	--1st byte data-->
	--2nd byte data-->
	~
	--(N-1)th byte data-->
	--Nth byte data<CR>-->
	<---R<CR>----

Execution :

String	Status Return	DVD player
BD<CR>		Park mode
	R<CR>	Receives the command and
20e40010....0267		starts the receiving data, 9320
43<CR>		bytes. It ends with <CR>.

 R<CR>

5.41 Weekly Timer Data Upload

Function : Reads the data of the Weekly Timer in the player.

Format : WU

Explanation : The player sends the Weekly Timer data to the computer if the player is Parked and if a disc is in the tray.

The Communication flows as follows.

Flow of the communication :

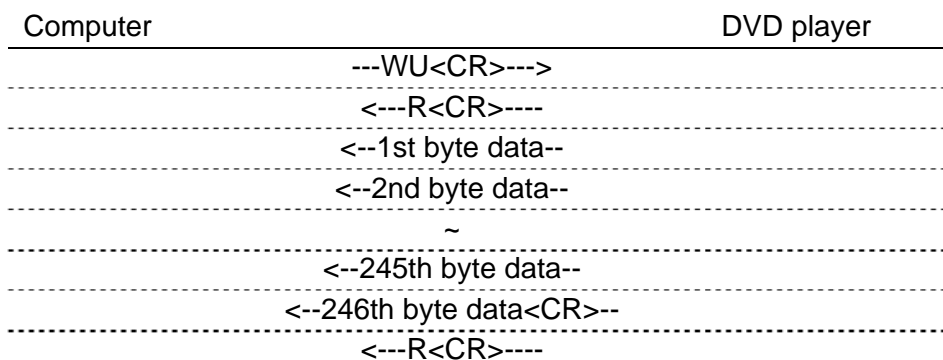

Format of the data :

BP	Contents	Numbers of bytes
0 - 1	(1) Total number of the transfer data. (fixed number = 00f6H)	2 bytes
	FIRST PAGE	
2	(2) Set the mode on Monday	1 bytes
3	(3) Set the ON hour on Monday	1 bytes
4	Set the ON minute on Monday	1 bytes
5	(4) Set the OFF hour on Monday	1 bytes
6	Set the OFF minute on Monday	1 bytes
7	(5) 00 (fixed data = 00H)	1 bytes
8	(6) Upper digit of Title number or Stack group number searched on Mon. (set with BCD)	1 bytes
9	Lower digit of Title number of Stack group number searched on Mon. (set with BCD)	1 bytes

10	(7) Upper digit of Chapter number searched on Mon. (set with BCD)	1 bytes
11	Lower digit of Chapter number searched on Mon. (set with BCD)	1 bytes
12	(2) Set the mode on Tuesday	1 bytes
~	(3) - (7) ~	~
22	(2) Set the mode on Wednesday	1 bytes
~	(3) - (7) ~	~
32	(2) Set the mode on Thursday	1 bytes
~	(3) - (7) ~	~
42	(2) Set the mode on Friday	1 bytes
~	(3) - (7) ~	~
52	(2) Set the mode on Saturday	1 bytes
~	(3) - (7) ~	~
62	(2) Set the mode on Sunday	1 bytes
63	(3) Set the ON hour on Sun.	1 bytes
64	Set the ON minute on Sun.	1 bytes
65	(4) Set the OFF hour on Sun.	1 bytes
66	Set the OFF minute on Sun.	1 bytes
67	(5) 00 (fixed data = 00H)	1 bytes
68	(6) Upper digit of Title number or Stack group number searched on Sun. (set with BCD)	1 bytes
69	Lower digit of Title number of Stack group number searched on Sun. (set with BCD)	1 bytes
70	(7) Upper digit of Chapter number searched on Sun. (set with BCD)	1 bytes
71	Lower digit of Chapter number searched on Sun. (set it with BCD)	1 bytes
72	(2) Set the mode on all days during a week	1 bytes
73	(3) Set the ON hour on all days during a week	1 bytes
74	Set the ON minute on all days during a week	1 bytes
75	(4) Set the OFF hour on all days during a week	1 bytes
76	Set the OFF minute on all days during a week	1 bytes
77	(5) 00 (fixed data = 00H)	1 bytes
78	(6) Upper digit of Title number or	1 bytes

	Stack group number searched on all days during a week (set with BCD)	
79	Lower digit of Title number of Stack group number searched on all days during a week (set with BCD)	1 bytes
80	(7) Upper digit of Chapter number searched on all days during a week (set with BCD)	1 bytes
81	Lower digit of Chapter number searched on all days during a week (set with BCD)	1 bytes
	SECOND PAGE	
82	(2) Set the mode on Monday	1 bytes
83	(3) Set the ON hour on Monday	1 bytes
84	Set the ON minute on Monday	1 bytes
85	(4) Set the OFF hour on Monday	1 bytes
86	Set the OFF minute on Monday	1 bytes
87	(5) 00 (fixed data = 00H)	1 bytes
88	(6) Upper digit of Title number or Stack group number searched on Mon. (set with BCD)	1 bytes
89	Lower digit of Title number of Stack group number searched on Mon. (set with BCD)	1 bytes
90	(7) Upper digit of Chapter number searched on Mon. (set with BCD)	1 bytes
91	Lower digit of Chapter number searched on Mon. (set with BCD)	1 bytes
92	(2) Set the mode on Tuesday	1 bytes
~	(3) - (7) ~	~
102	(2) Set the mode on Wednesday	1 bytes
~	(3) - (7) ~	~
112	(2) Set the mode on Thursday	1 bytes
~	(3) - (7) ~	~
122	(2) Set the mode on Friday	1 bytes
~	(3) - (7) ~	~
132	(2) Set the mode on Saturday	1 bytes
~	(3) - (7) ~	~
142	(2) Set the mode on Sunday	1 bytes
143	(3) Set the ON hour on Sun.	1 bytes
144	Set the ON minute on Sun.	1 bytes
145	(4) Set the OFF hour on Sun.	1 bytes

146	Set the OFF minute on Sun.	1 bytes
147	(5) 00 (fixed data = 00H)	1 bytes
148	(6) Upper digit of Title number or Stack group number searched on Sun. (set with BCD)	1 bytes
149	Lower digit of Title number of Stack group number searched on Sun. (set with BCD)	1 bytes
150	(7) Upper digit of Chapter number searched on Sun. (set with BCD)	1 bytes
151	Lower digit of Chapter number searched on Sun. (set it with BCD)	1 bytes
152	(2) Set the mode on all days during a week	1 bytes
153	(3) Set the ON hour on all days during a week	1 bytes
154	Set the ON minute on all days during a week	1 bytes
155	(4) Set the OFF hour on all days during a week	1 bytes
156	Set the OFF minute on all days during a week	1 bytes
157	(5) 00 (fixed data = 00H)	1 bytes
158	(6) Upper digit of Title number or Stack group number searched on all days during a week (set with BCD)	1 bytes
159	Lower digit of Title number of Stack group number searched on all days during a week (set with BCD)	1 bytes
160	(7) Upper digit of Chapter number searched on all days during a week (set with BCD)	1 bytes
161	Lower digit of Chapter number searched on all days during a week (set with BCD)	1 bytes
	THIRD PAGE	
162	(2) Set the mode on Monday	1 bytes
163	(3) Set the ON hour on Monday	1 bytes
164	Set the ON minute on Monday	1 bytes
165	(4) Set the OFF hour on Monday	1 bytes
166	Set the OFF minute on Monday	1 bytes
167	(5) 00 (fixed data = 00H)	1 bytes
168	(6) Upper digit of Title number or Stack group number searched on	1 bytes

	Mon. (set with BCD)	
169	Lower digit of Title number of Stack group number searched on Mon. (set with BCD)	1 bytes
170	(7) Upper digit of Chapter number searched on Mon. (set with BCD)	1 bytes
171	Lower digit of Chapter number searched on Mon. (set with BCD)	1 bytes
172	(2) Set the mode on Tuesday	1 bytes
~	(3) - (7) ~	~
182	(2) Set the mode on Wednesday	1 bytes
~	(3) - (7) ~	~
192	(2) Set the mode on Thursday	1 bytes
~	(3) - (7) ~	~
202	(2) Set the mode on Friday	1 bytes
~	(3) - (7) ~	~
212	(2) Set the mode on Saturday	1 bytes
~	(3) - (7) ~	~
222	(2) Set the mode on Sunday	1 bytes
223	(3) Set the ON hour on Sun.	1 bytes
224	Set the ON minute on Sun.	1 bytes
225	(4) Set the OFF hour on Sun.	1 bytes
226	Set the OFF minute on Sun.	1 bytes
227	(5) 00 (fixed data = 00H)	1 bytes
228	(6) Upper digit of Title number or Stack group number searched on Sun. (set with BCD)	1 bytes
229	Lower digit of Title number of Stack group number searched on Sun. (set with BCD)	1 bytes
230	(7) Upper digit of Chapter number searched on Sun. (set with BCD)	1 bytes
231	Lower digit of Chapter number searched on Sun. (set it with BCD)	1 bytes
232	(2) Set the mode on all days during a week	1 bytes
233	(3) Set the ON hour on all days during a week	1 bytes
234	Set the ON minute on all days during a week	1 bytes
235	(4) Set the OFF hour on all days during a week	1 bytes

236	Set the OFF minute on all days during a week	1 bytes
237	(5) 00 (fixed data = 00H)	1 bytes
238	(6) Upper digit of Title number or Stack group number searched on all days during a week (set with BCD)	1 bytes
239	Lower digit of Title number of Stack group number searched on all days during a week (set with BCD)	1 bytes
240	(7) Upper digit of Chapter number searched on all days during a week (set with BCD)	1 bytes
241	Lower digit of Chapter number searched on all days during a week (set with BCD)	1 bytes
242 - 245	Checksum	4 bytes

(1) Fixed data:

indicates the total data bytes of this transfer with HEX digit
00f6H = 246 byte

(2)

indicates the player mode when the player turns ON

It specifies the player mode as follows.

Upper nibble

4: The player will seek the Title and Chapter that is written in the data

8: The player will execute the Stack that is specified in the data

Lower nibble (indicates the day)

0: Monday

1: Tuesday

2: Wednesday

3: Thursday

4: Friday

5: Saturday

6: Sunday

7: ALL

(3)

indicates the hour that the player's power turns ON

The hour (expressed as 00 through 23) is used with the minutes (expressed as 00 through 59). The ffH means that the hour is not written.

(4)

indicates the minute that the player's power turns ON

The minute minutes (expressed as 00 through 59) is used with the hour. The ffH means that the minute is not written.

(5) Fixed data:

00H

(6)

indicates the upper and lower digit of Title number or Stack group number according to the player mode in which it is written (refer to 2)

When the upper nibble of the mode is 4, it indicates a Title number. When the setting is 8, it indicates a Stack group number (shown with BCD).

(7)

indicates the upper and lower digit of Chapter number or Stack group number according to the player mode in which it is written (refer to 2)

When the upper nibble of the mode is 4, it indicates a Chapter number. When the setting is 8, it fixes 00H as upper and 01H as lower (shown with BCD).

(8)

checksum of the data that indicates the result of adding from BP 0 to BP 242 (shown with HEX (double word))

Example :

Monday, Turning ON at 8:30 (AM) and turning OFF at 17:20 (5:20 PM) / seek Title 20, Chapter 5

Tuesday, Turning ON at 9:30 only. Execute Stack group 123.

BP	Data	Explanations
0	00H	
1	4cH	
2	40H	The mode of Monday
3	08H	8 o'clock (Hour to turn ON)
4	30H	30 minutes (Minute to turn ON)
5	17H	17 o'clock (Hour to turn OFF)
6	20H	20 minutes (Minute to turn ON)
7	00H	Fixed data
8	00H	The upper digit of Title number

9	20H	The lower digit of Title number
10	00H	The upper digit of Chapter number
11	05H	The lower digit of Chapter number
12	81H	The mode of Tuesday
13	09H	9 o'clock
14	30H	30 minutes
15	ffH	
16	ffH	
17	00H	Fixed data
18	01H	The upper digit of Stack group
19	23H	The lower digit of Stack group
20	00H	Fixed data
21	01H	Fixed data
22		~
~		~

Execution :

String	Status Return	DVD player
WU<CR>		Park mode
	R<CR>	Receives the command and
	004c4008....00	starts the transfer of the data,
	1ab6<CR>	246 bytes. It ends with <CR>.
	R<CR>	

5.42 Weekly Timer Data Download

Function : Sends the Weekly Timer data to the player

Format : WD

Explanation : The computer writes the Weekly Timer data while the player is Parked.

Refer to the description for Weekly Timer Data Upload.

The Communication flows as follows.

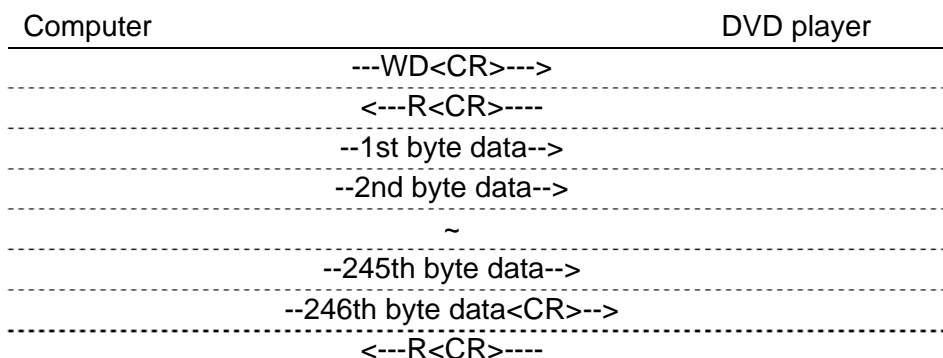

Execution :

String	Status Return	DVD player
WD<CR>		Park mode
004c4008....001a b6<CR>	R<CR>	Receives the command and starts the transfer of the data, (246 bytes) then ends with <CR>
	R<CR>	

5.43 Output Select

Function : Switch the composite video outputs and analog audio output.

Format : Integer OS

Explanation : Integer is 3 digits(C₁ C₂ C₃).

C ₁ MONITOR OUT	0: DVD	1: EXT IN	9: hold
C ₂ VIDEO OUT	0: DVD	1: EXT IN	9: hold
C ₃ AUDIO OUT	0: DVD	1: EXT IN	9: hold

Execution :

String	Status Return	DVD player
9110S<CR>	R<CR>	MONITOR OUT keeps the current condition, VIDEO OUT and AUDIO OUT switches to EXT IN.
1000S<CR>	R<CR>	MONITOROUT switches to EXT IN, VIDEO OUT and AUDIO OUT switches to DVD.

5.44 DVD VR Play Mode (DVD VR)

Function : Set the playing mode of DVD Video Recording format.

Format : Integer VP

Explanation : This command is available only for DVD VR (Video Recording format) . In other case player returns the error E04.

And this command is available in stop mode. If player receives this command in other mode, player returns error E04.

The default setting is original mode.

<u>Argument</u>	<u>Function</u>
0	Original mode
1	Play List mode

5.45 Repeat Mode

Function : Set the repeat mode

Format : RM

Explanation : Player sets the repeat mode according to the address mode and returns the complete status. In case of invalid address mode player returns the error E04.

When address mode is 'Title'	: Title Repeat
When address mode is 'Chapter'	: Chapter Repeat
When address mode is 'Track'	: Track Repeat
Others	: Invalid

Execution :

<u>String</u>	<u>Status Return</u>	<u>DVD Player</u>
TI3SLRM<CR>	R<CR>	Search title 3 and play in title repeat mode.
TI4SECH5SLRM<CR>	R<CR>	Search chapter 5 of title 4 and play in chapter repeat mode.

NOTE : This command functions only to set the repeat mode and makes no limitation for execution of next command. Therefore the repeat mode can be canceled by next command.

For example, when player receives TI3SLRM command, title repeat mode is set. But when TI4SL command is executed after that, title repeat mode is canceled. If it is need to play title 4 in title repeat mode, it is need to send RM command again.

5.46 General Purpose Parameter

DVD-V8000 has the 26 internal parameters(parameter A,B,C, ··· ,Z) and has the commands to operate the parameters as below.

- command to substitute value for the parameter
- command to read the parameter
- command to refer the parameter

The ranges of the value which can be substituted for the parameter A - Z are 0 - 99999999.

Function : Substitute value for the parameter
 Format : Integer>A Substitute for parameter A
 Integer>B Substitute for parameter B

 Integer>Z Substitute for parameter Z

Function : Refer the parameter
 Format : _A Refer parameter A
 _B Refer parameter B

 _Z Refer parameter Z

Function : Return value of the parameter
 Format : <A Return value of parameter A
 <B Return value of parameter B

 <Z Return value of parameter C

Execution :

String	Status Return	DVD Player
1>A<CR>	R<CR>	Substitute 1 for parameter A
2>B<CR>	R<CR>	Substitute 2 for parameter B
5>C<CR>	R<CR>	Substitute 5 for parameter C
6>D<CR>	R<CR>	Substitute 6 for parameter D
5000>E<CR>	R<CR>	Substitute 5000 for parameter E
6000>F<CR>	R<CR>	Substitute 6000 for parameter F
TI_ASE<CR>	R<CR>	Search title 1 (same as TI1SE)
CH_CSE_DPL<CR>	R<CR>	Search chapter 5 and play to chapter 6 (same as CH5SE6PL)
TI_BSE<CR>	R<CR>	Search title 2 (same as TI2SE)
FR_ESE_FPL<CR>	R<CR>	Search frame 5000 and play to frame 6000 (same as FR5000SE6000PL)
<A	00000001<CR>	Return the value of parameter A
<F	00006000<CR>	Return the value of parameter F

5.47 Chapter Skip

Function : Chapter / Track skip

Format : Integer SK

Explanation : Search the previous chapter, current chapter or next chapter corresponding to the argument.

When a search is prohibited, an error E04 is returned.

Argument	Function
1	Search the next chapter
2	Search the previous chapter
3	Search the current chapter

6. CURRENT PLAYER CONDITION REQUEST DESCRIPTIONS

6.1 P-Block Number Request

Function : The command returns information for the following groups:
 DVD – Title Numbers, Chapter Numbers, Time
 CD/VCD – Track Numbers, Index Numbers, Block Numbers, Time

Format : ?A

Explanation : If the P-Block Number Request command is sent to a DVD disc, Title numbers, Chapter numbers and Time Code information are grouped together then the data is returned in a single report. A request sent to a CD/VCD disc returns Track numbers, Index numbers, Block numbers and Time Codes.

If the player is in Random Access Mode, the report contains correct values.

NOTE: The Time Code shows the elapsed time based on the chapter when playing DVD Video disc. And it shows the elapsed time based on the title when playing DVD VR disc.

Execution :

String	Status Return	DVD player
?A<CR>	1201033545<CR>	Play mode (CD) <i>Track 12, Index 1, 3 minutes, 35 seconds 45 Blocks</i>
?A<CR>	0135001247<CR>	Play mode (DVD) <i>Title 1, Chapter 35, 12 minutes, 47 seconds</i>

6.2 Title/Track Number Request

Function : Returns the current Title/Track number

DVD : Title
 CD/VCD : Track

Format : ?R

Explanation : The player returns the contents of the Title/Track Number Register. The Track number is a 2-digit integer. Correct values show only when the player is in Random Access Mode.

Execution :

String	Status Return	DVD player
?R<CR>	12<CR>	Play mode (CD) <i>Player plays Track 12</i>

6.3 Chapter Number Request (DVD)

Function : Returns the current Chapter number

Format : ?C

Explanation : The player returns the contents of the Chapter Number Register. The Chapter number is a 2-digit integer. If a disc does not have Chapter numbers, the player returns an error message (E04). Correct values show only when the player is in Random Access Mode.

Execution :

String	Status Return	DVD player
?C<CR>	12<CR>	Play mode (DVD) <i>Player plays Chapter 12</i>

6.4 Time Code Request

Function : Returns the current Time Code

Format : ?T

Explanation : The player returns the contents of the Current Time/Frame Register.

A 3-digit number is assigned for minutes and a 2-digit number is assigned for seconds.

If the player is in Random Access mode, the returned value is current.

If a disc lacks Time information, the player returns error message E04.

If a disc Time Code fails to be read correctly, the player retains the previous Time Code.

Execution :

String	Status Return	DVD player
?T<CR>	11742<CR>	Play mode <i>117 minutes, 42 seconds</i>

6.5 Block Number Request (CD)

Function : Returns the current Block number

Format : ?B

Explanation : The player returns the value of the current Block number as a 7-digit integer. Correct values show only when the player is in Random Access mode.

If a Block number is unavailable, the player retains the previous value.

Execution :

String	Status Return	DVD player
?B<CR>	0115310<CR>	Play mode 11 min, 53 sec, 10 Blocks

6.6 Frame Number Request (DVD)

Function : Returns the current Frame number

Format : ?F

Explanation : The player returns the contents of the Current Frame Register.

The player may experience a conflict between the command receiving/handling and the Frame number updating. Thus, continuous Frame numbers may be unavailable when the system is in Playback mode.

If the command is sent to a disc without Frame numbers, the player returns error message E04.

Accurate, current values are available when the player is in Random Access mode.

If a disc Frame number is unavailable, the player retains the previous value.

Execution :

String	Status Return	DVD player
?F<CR>	0002047<CR>	Play mode Frame 2047

6.7 Index Number Request (CD)

Function : Returns the current Index number

Format : ?I

Explanation : The player returns the current Index number as a 4-digit integer. Correct values show only when the player is in Random Access Mode.

Execution :

String	Status Return	DVD player
?I<CR>	0102<CR>	Play mode <i>Track 1, Index 2</i>

6.8 Total Frame Request (DVD)

Function : Returns the total Frame number of the current Title

Format : ?Y

Explanation : The player returns the total Frame number of the current Title.

Execution :

String	Status Return	DVD player
?Y<CR>	0124832<CR>	Play mode <i>Frame 124832</i>

6.9 TOC Information Request

Function : Returns the Table of Contents (TOC) information

Format : ?Q

Explanation : The player returns the Track number of the first Track, the Track number of the last Track and the absolute time of starting lead-out.

Status information is returned in the following format when CD or Video CD is loaded:

C₁C₂C₃C₄C₅C₆C₇C₈C₉C₁₀<CR>

C ₁ C ₂	first Track number
C ₃ C ₄	last Track number
C ₅ C ₆ C ₇ C ₈ C ₉ C ₁₀	absolute Time of starting lead-out

Execution :

String	Status Return	DVD player
?Q<CR>	0109665544<CR>	Play mode <i>first Track is 1, last Track is 9, lead-out Time is 66 min, 55 sec, 44 Blocks</i>

Status information is returned in the following format when DVD is loaded:

C₁C₂C₃C₄C₅C₆C₇C₈C₉C₁₀<CR>

C ₁	Disc type DVD Video : V DVD VR : R
C ₂	DVD VR with Play List : 1 Others : 0
C ₃	Playing according to a Play List : 1 Others : 0
C ₄	Always 0
C ₅	Always 0
C ₆ C ₇	Number of total title
C ₈ C ₉ C ₁₀	Number of total chapter of playing title

6.10 Disc Region Code Request (DVD)

Function : Returns the region code of the disc

Format : ?G

Explanation : The player returns the approved region code(s) designated on the disc. Each bit indicates a region in a returned byte from the player. Bit 0 (LSB) indicates region 1, bit 1 indicates region 2, ..., bit 5 indicates region 6. Value 0 shows the disc as playable in its region.

Execution :

String	Status Return	DVD player
?G<CR>	F9<CR> (=11111001B)	Play mode <i>Region code 2 and 3</i>
?G<CR>	C0<CR> (=11000000B)	Play mode <i>Region code 1, 2, 3, 4, 5 and 6 (ALL)</i>

6.11 DVD Disc Status Request

Function : Returns the attributes of the DVD disc being played

Format : ?V

Explanation : The player returns the attributes of a DVD disc. Discs other than DVD, cause the player to return an error message (E04).

Status information is returned in the following format:

C₁C₂C₃C₄C₅<CR>

C ₁	Disc Mount	0 = No	1 = Yes	X = Unknown
C ₂	Layer Structure	0 = Single	1 = Dual	X = Unknown
C ₃	Path Type	0 = Parallel	1 = Opposite	X = Unknown
C ₄	Chapter Search	0 = Disable	1 = Available	X = Unknown
C ₅	Time Search	0 = Disable	1 = Available	X = Unknown

Execution :

String	Status Return	DVD player
?V<CR>	0XXXX<CR>	<i>Disc is not mounted</i>
?V<CR>	10010<CR>	<i>available Chapter Search but disable Time Search</i>
?V<CR>	E04<CR>	<i>Error – except DVD disc loaded</i>

6.12 CD Disc Status Request

Function : Returns the attributes of the CD disc being played

Format : ?K

Explanation The player returns the attributes of the CD disc. If the disc is other than a CD, the player returns an error message (E04).

Status information is returned in the following format:

C₁C₂C₃C₄C₅C₆C₇C₈<CR>

C ₁	Disc Mount	0 = No	1 = Yes	X = Unknown
C ₂	Not Used	X (fixed)		
C ₃	Not Used	X (fixed)		
C ₄	Not Used	X (fixed)		
C ₅	Not Used	X (fixed)		
C ₆	VCD	0 = No	1 = Yes	X = Unknown
C ₇	Reserved	X (fixed)		
C ₈	Reserved	X (fixed)		

Execution :

String	Status Return	DVD player
?K<CR>	0XXXXXXXX<CR>	<i>Disc is not mounted</i>
?K<CR>	1XXXX1XX<CR>	<i>VCD</i>
?K<CR>	E04<CR>	<i>DVD</i>

6.13 Register A Set

Function : The current setting of Register A is rewritten

Format : Integer RA

Explanation : The command rewrites detailed display attributes into Register

A. The player offers three settings:

- Frame Number/Time code
- Title, Chapter Number/Track Number
- User's Area

NOTE: The displayed Frame number attempts to auto-correct to the actual Frame number, however, Frames continue to advance during playback.

Note: When selecting Frame Number/Time code while playing a DVD disc, the Frame Number is displayed on the screen. However, when playing back a DVD disc and selecting Time Code(DVD), Time Code is displayed. Time Code is displayed when playing back a CD or VCD disc.

The available display combinations are listed in the following table (Default value is 3):

Arg	Function	User's	T&CH / Track	Frame / Time	Time (DVD)
0	Display OFF	0	0	0	0
1	Frame Number (DVD)/Time Code (CD,VCD)	0	0	1	0
2	Title & Chapter Number/Track Number	0	1	0	0
3 (default)	Frame Number (DVD) / Time Code (CD, VCD) + Title, Chapter, Frame/Track, Time	0	1	1	0
4	User's area	1	0	0	0
5	User's area + Argument 1	1	0	1	0
6	User's area + Argument 2	1	1	0	0
7	User's area + Argument 3	1	1	1	0
11	Time Code (DVD, CD, VCD)	0	0	1	1
13	Time Code (DVD, CD, VCD) + Title & Chapter Number/Track Number	0	1	1	1
15	Time Code (DVD, CD, VCD) + User's Area	1	0	1	1
17	Time Code (DVD, CD, VCD) + Title & Chapter Number/Track Number + User's Area	1	1	1	1

The Display Control command turns the character display ON or OFF. The Register A Set command specifies what is displayed on the screen.

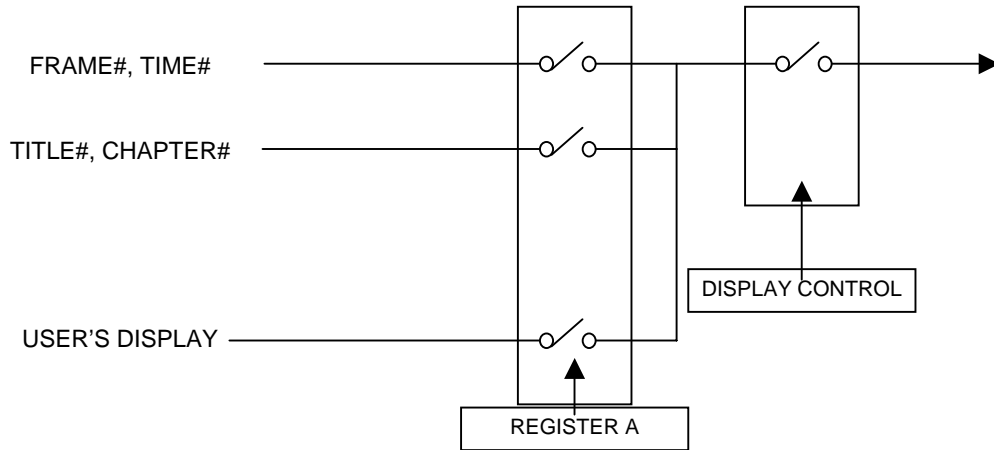

The screen display positions are pictured below.

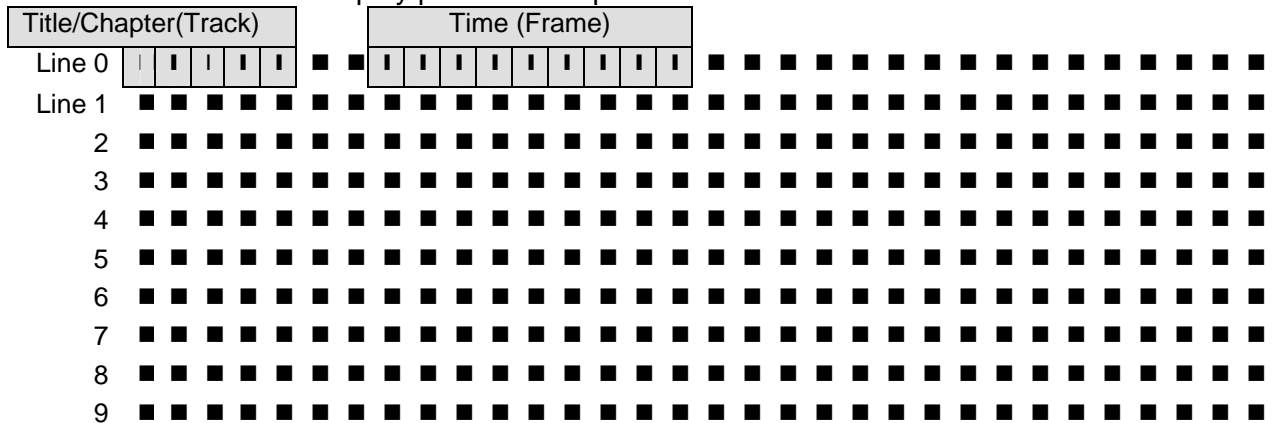

Line 0 displays the Time Code/Frame Number and/or Title/Chapter/Track Number(s).

The user's area has lines numbered from 0 to 9 with a total of 10 lines available. If line 0 is designated to show system information, all following lines are hidden.

The player allows/displays up to 320 characters (32 characters per line with 10 lines available). Follow the instructions below to create a User's Display:

1. Select User's Display in Register A
2. Set the display data using a print character command
3. Turn display switch ON

Execution :

String	Status Return	DVD player
1DS<CR>	R<CR>	Display Off to Display On
1RA<CR>	R<CR>	<i>Only Frame number is displayed</i>

6.14 Register D Set

Function : current setting of Register D is rewritten

Format : Integer RD

Explanation : Register D contains the termination setting of the serial communication (RS232). There are two choices, "CR" or "CR + LF". The default for Register D is 0.

Argument	Function
0 (default)	CR
64	CR + LF

6.15 Print Character

Function : Characters are written into the User's Display Area
(Not to be issued simultaneously with other commands)

Format : Integer PR <CR>
Character string <CR>

Explanation : The command writes a character string for one line into the User Display Area (turn ON the User Display Specification in Register A).

Follow the instructions listed below to create printed characters.

1. Specify the line number using an integer in the range 0 ~ 9
2. Enter the command character PR
3. Enter the terminate code <CR>
4. Specify the character string to enter in the next command string
(enter a character string up to 32 characters in length)

Available characters are shown in the table below (from 20h through 9Fh):

	0	1	2	3	4	5	6	7	8	9	A	B	C	D	E	F
2		!	"	#	\$	%	&	'	()	*	+	,	-	.	/
3	0	1	2	3	4	5	6	7	8	9	:	;	<	=	>	?
4	@	A	B	C	D	E	F	G	H	I	J	K	L	M	N	O
5	P	Q	R	S	T	U	V	W	X	Y	Z	[¥]	^	_
6	'	a	b	c	d	e	f	g	h	i	j	k	L	m	n	o
7	p	q	r	s	t	u	v	w	x	y	z	{		}	~	*1
C	À	Á	Â	Ã	Ä	Å	Æ	Ç	È	É	Ê	Ë	Ì	Í	Î	Ï
D	Ð	Ñ	Ò	Ó	Ô	Õ	Ö	×	Ø	Ù	Ú	Û	Ü	Ý	Þ	ß
E	à	á	â	ã	ä	å	æ	ç	è	é	ê	ë	ì	í	î	ï
F	ð	ñ	ò	ó	ô	õ	ö	÷	ø	ù	ú	û	ü	ý	þ	ÿ

*1 cannot be used

Execution :

String	Status Return	DVD player
4RA1DS<CR>	R<CR>	<i>Register A and Display control set</i>
4PR<CR>	R<CR>	<i>Select Line 4</i>
*** DVD player ***<CR>	R<CR>	<i>Displays the characters like this ***DVD player***</i>

6.16 Clear Screen

Function : Clears the characters shown in the User Display Area

Format : CS

Explanation : The player clears all characters from the User Display area. To clear only a particular line, use the PR command to overwrite the line with spaces.

Execution :

String	Status Return	DVD player
CS<CR>	R<CR>	<i>All lines are cleared</i>
3PR<CR>	R<CR>	<i>Select line 3</i>
HELLO!<CR>	R<CR>	<i>Write letters on line 3, HELLO!</i>

6.17 Real Time Clock Set

Function : Sets the real time clock

(Not to be issued simultaneously with other commands)

Format : WW <CR>

7 fields integer <CR> (=YYMMDDWWHHMMSS<CR>)

Explanation : The real time clock may be set using the following format:

YY	the last two digits of year
MM	month
DD	date
WW	day, 00 means Monday, 06 means Sunday
HH	hour 24-hour format
MM	minute
SS	second

NOTE: Input the 7-bytes integer as a single entry. If an integer is less than 7-bytes in length, the player returns an error message.

Execution :

String	Status Return	DVD player
WW<CR>	R<CR>	<i>Set Real Time Clock setting mode</i>
06051500123456<CR>	R<CR>	<i>Sets Monday, May 15t, 12:34:56, 2006</i>

6.18 Advanced Setup

Function : current setting of Advanced Setup Menu is rewritten

Format : Integer MS

Explanation : The command rewrites the Advanced Setup Menu settings, which is expressed as an integer. The integer value is made up of the sum of the selected arguments. The player returns an error code if the command is issued while the Advanced Setup Menu is on the screen. The factory default value is 0.

The Advanced Setup Request command (?S) reveals the current setting.

Argument	Function	Description	
		0	1
1	WEEKLY TIMER	OFF	ON
2	POWER ON START	OFF	ON
4	TITLE PLAY MODE	SINGLE	ALL
8	REPEAT MODE	(0) OFF, (8) CHAPTER (16) TITLE, (24) DISC *1)	
16			

32	REMOTE CONTROL	Enable	Disable
64	TRAY	Enable	Disable
128	FRONT KEY	Enable	Disable
256	BLACKBOARD LOCK	OFF	ON
512	REV STEP/REV PLAY	Resolution	Smooth
1024	PLAYER CONTRAL PANEL	(0) Selectable	
2048		(1024) Always off (2048) Always on	
4096	SETUP LOCK	ON	OFF
8192	EXTEND TERMINAL	Standard	User
16384	EXTERNAL SYNC	(0) OFF	
32768		(16384) NTSC (32768) PAL	
65536	MONITOR OSD	(0) Bottom	
131072		(65536) Top (131072) OFF	
262144	AUTO PASS THROUGH	OFF	ON
524288	PLAY START MODE	TITLE 1	TOP MENU
1048576	BAUD RATE	(0) 4800	
2097152		(1048576) 9600 (2097152) 19200	
4194304	SYNC OUT(DURING SQ)	OFF	ON
8388608	MOUSE CURSOR	ON	OFF
16777216	GOTO DVD-MENU (LEFT)	OFF	ON
33554432	GOTO DVD-MENU (RIGHT)	OFF	ON

*1): (Available when Title Play Mode is set to ALL)

The setting value is calculated as follows.

$$\begin{aligned}
 \text{value} = & \underline{1*(0 \text{ or } 1)} + \underline{2*(0 \text{ or } 1)} + \underline{4*(0 \text{ or } 1)} + \underline{(0 \text{ or } 8 \text{ or } 16 \text{ or } 24)} \\
 & \text{WEEKLY TIMER POER ON START TITLE PLAY MODE REPEAT MODE} \\
 & + \underline{32*(0 \text{ or } 1)} + \underline{64*(0 \text{ or } 1)} + \underline{128*(0 \text{ or } 1)} + \underline{256*(0 \text{ or } 1)} \\
 & \text{REMOTE CONTROL TRAY FRONT KEY BLACKBOARD LOCK} \\
 & + \underline{512*(0 \text{ or } 1)} + \underline{(0 \text{ or } 1024 \text{ or } 2048)} + \underline{4096*(0 \text{ or } 1)} \\
 & \text{REV STEP/REV PLAY PLAYER CONTROL PANEL SETUP LOCK} \\
 & + \underline{8192*(0 \text{ or } 1)} + \underline{16384*(0 \text{ or } 1 \text{ or } 2)} \\
 & \text{EXTEND TERMINAL EXTERNAL SYNC} \\
 & + \underline{65536*(0 \text{ or } 1 \text{ or } 2)} + \underline{262144*(0 \text{ or } 1)} + \underline{524288*(0 \text{ or } 1)} \\
 & \text{MONITOR OSD AUTO PASS THROUGH PLAY START MODE} \\
 & + \underline{1048576*(0 \text{ or } 1 \text{ or } 2)} + \underline{4194304*(0 \text{ or } 1)}
 \end{aligned}$$

$$+ \frac{8388608}{1000000} * (0 \text{ or } 1) + \frac{16777216}{1000000} * (0 \text{ or } 1) + \frac{33554432}{1000000} * (0 \text{ or } 1)$$

MOUSE CURSOR GOTO DVD-MENU(LEFT) GOTO DVD-MENU(RIGHT)

Execution :

String	Status Return	DVD player
112MS<CR>	R<CR>	<i>Title repeat mode (16)</i> <i>REMOTE CONTROL Disable (32)</i> <i>TRAY Disable (64)</i>

6.19 Communication Control Set

Function : Selects the communication mode

Format : Integer CM

Explanation : command rewrites the contents of the Communication Control Register (CCR)

The CCR default value is set to Mode 3 (ON); however, the CCR Automatic Status may be switched OFF. Use the command to toggle the register ON or OFF.

Argument	Mode	Auto Status
2	Mode-2	OFF
3	Mode-3	ON

Execution :

String	Status Return	DVD player
2CM<CR>		CCR = 3 (<i>Default Communication Mode</i>) to CCR = 2 (<i>Communication Mode-2</i>)

6.20 Player Active Mode Request

Function : returns the player's current activity mode

Format : ?P

Explanation : The command confirms whether the player is running in the Random Access mode. The player returns an Active mode classification (refer to the table below).

Mode	Status
P00	Open
P01	Park
P02	Setup
P03	Unload

Mode	Status
P05	Still
P06	Pause
P07	Search
P08	Scan

P04	Play	P09	Multi-speed
-----	------	-----	-------------

The following table provides fuller explanations for each Active mode:

P00 (Open)	Disc tray is open
P01 (Park)	Disc rotation is stopped
P02 (Setup)	Preparation is being made for playback
P03 (Unload)	Disc rotation stops and disc tray opens
P04 (Play)	Audio and video are played at normal speed
P05 (Still)	Playback stops with video held on screen
P06 (Pause)	Playback stops and video is erased from screen
P07 (Search)	A specified address is searched for, a multi-track jump is in progress, or a Search for user's code is in progress
P08 (Scan)	Fast forward/reverse is in progress
P09 (Multi-speed)	Playback occurs at any one of several speeds

Execution :

String	Status Return	DVD player
		Play mode
?P<CR>	P04<CR>	
ST<CR>	R<CR>	Still mode
?P<CR>	P05<CR>	

6.21 Player Model Name Request

Function : Returns player model name

Format : ?X

Explanation : The command returns the player's name as P1571XX where P1571 is the series name and XX is a 2-digit serial code (not the product serial number).

Execution :

String	Status Return	DVD player
?X<CR>	P157100<CR>	<i>Series name P1571 and code 00</i>

6.22 Real Time Clock Request

Function : returns the Real Time Clock information

Format : ?W

Explanation : The command returns the Real Clock time.

YY	the last two digits of year
MM	month
DD	date
WW	day, 00 means Monday, 06 means Sunday
HH	hour 24-hour format
MM	minute
SS	second

Execution :

String	Status Return	DVD player
?W<CR>	06042104142520<CR>	<i>Friday, April 21, 2006, 2:25:20 PM</i>

6.23 Advanced Setup Request

Function : Returns the current setting of Advanced Setup Menu.

Format : ?S

Explanation : The player returns the current setting of the Advanced Setup Menu. The return is expressed as an integer value. The value is made up of the sum of the selected arguments. The factory default is set to 0. The player returns an error code if the command is issued when the player is showing Advanced Setup Menu on the screen. See the description of Advanced Setup (MS).

NOTE: E04 is returned from a player when the command is issued while the Advanced Setup Menu is displayed.

Execution :

String	Status Return	DVD player
?S<CR>	112<CR>	<i>Title repeat mode (16) Baud rate is 9600bps (32) Tray lock on (64)</i>

6.24 Player Region Code Request

Function : Returns player region code

Format : ?H

Explanation : The command returns the player's region code.

Execution :

String	Status Return	DVD player
?H<CR>	02<CR>	<i>Region Code 2</i>

6.25 CCR Mode Request

Function : Returns the current communication mode

Format : ?M

Explanation : The command returns the contents of the Communication Control Register (CCR).

The CCR default value is set to Mode 3 (ON).

CM2	Mode-2
CM3	Mode-3

Execution :

String	Status Return	DVD player
?M<CR>	CM3<CR>	CCR = 3 (<i>Default Communication Mode</i>)

6.26 Input Number Request

Function : returns input numbers

Format : ?N

Explanation : The player waits the input of number from the remote controller and returns the input number.

Execution :

String	Status Return	DVD player
?N<CR>		<i>Waits to input the numeric numbers</i>
7<CR>	7<CR>	<i>7 entered from remote controller</i>

6.27 Error Code Request

Function : returns the latest error code

Format : ?E

Explanation : The player returns the most recent error codes. The “error code” means the error that the player returned for a command (Ex. E04).

6.28 Input Unit Request

Function : returns a code for data input through a Remote control

Format : #I

Explanation : The player returns a four-digit ASCII-Hex code that represents commands sent through the remote control.

There are two code types, either a four-digit or eight-digit code (Extension code). When the input command data is two words (eight-digit) in length, the player truncates or shortens the information. A truncated code consists of an Upper Byte from the first code and a Lower Byte from the second code. The player creates a Returning Code or Double Code from these two bytes.

Once the player returns an Input Code, a FFFFh Code (no reactions from the remote control) repeats until a new code is sent from the remote control.

Execution :

String	Status Return	DVD player
		<i>Receives the Pause Key command -A39F</i>
#I<CR>	A39F<CR>	
#I<CR>	FFFFh<CR>	
		<i>Receives the Audio Key command - A399_A3BE</i>
#I<CR>	A3BE<CR>	
#I<CR>	FFFFh<CR>	

6.29 Register A Request

Function : returns the contents of Register A

Format : \$A

Explanation : The player returns a detailed list of the Register A attributes.

Status information is returned in the following format:

AC₈C₇C₆C₅C₄C₃C₂C₁<CR>

C ₈ , C ₇ , C ₆	(Fixed 0)		
C ₅	Displays Time Code when playing DVD	0 = Off	1 = On
C ₄	(Fixed 0)		
C ₃	Displays User's Area	0 = Off	1 = On
C ₂	Displays Title & Chapter Numbers	0 = Off	1 = On
C ₁	Displays Frame Number (DVD) or Time Code (CD, VCD)	0 = Off	1 = On

Execution :

String	Status Return	DVD player
3RA<CR>	R<CR>	<i>Sets to Register A</i>
\$A<CR>	A00000011<CR>	<i>Requests information from Register A</i>

6.30 Register D Request

Function : returns the contents of Register D

Format : \$D

Explanation : The player returns the TxD termination setting from Register D

Status information is returned in the following format:

DC₈C₇C₆C₅C₄C₃C₂C₁<CR>

C ₈	Fixed 0		
C ₇	TxD termination	0 = CR	1 = CR + LF
C ₆	Fixed 0		
C ₅	Fixed 0		
C ₄	Fixed 0		
C ₃	Fixed 0		
C ₂	Fixed 0		
C ₁	Fixed 0		

Execution :

String	Status Return	DVD player
64RD<CR>	R<CR>	<i>Sets the Register D</i>
\$D<CR>	D0100000<CR>	<i>Requests information from Register D</i>

6.31 Menu Call (DVD)

Function : calls a disc menu or goes back to the former address

Format : Integer MC

Explanation : If the disc has a disc menu, the root menu or the Title menu comes up on the screen. If the screen is Still or if it is playing, these menus come up on the display. The command specifies the menu type with two integer numbers.

<u>Integer</u>	<u>Menu type</u>
1	Title
2	Root

If the player receives the command without an integer (while playing a menu), the player reverts to the previous Stilled or played address.

If the command is valid for the situation, the player immediately returns "R<CR>".

If the disc is missing the requested menu, [1 or 2 MC<CR>], the player returns an error message (E04).

*: However, the command is held or incompletely executed.

Execution :

String	Status Return	DVD player
		Plays some video Title
2MC<CR>	R<CR>	Shows the root menu
MC<CR>	R<CR>	Reverts back to the previously played Title

6.32 Numeric Button (DVD)

Function : Selects the button and executes by number

Format : Integer NB

Explanation : The command selects the menu button highlighted on the screen and executes the action assigned to the button. The command emulates the “digit” key on the remote control while the button resides on the display.

If the command is valid for the current player activity, the player immediately returns “R<CR>”.*

If the disc that is being played does not have the button in that screen when the command is issued, an error message (E06) is returned.

* However, this does not confirm that the command is executed completely.

Execution :

String	Status Return	DVD player
		Shows the disc menu
3NB<CR>	R<CR>	Selects and executes the button #3

6.33 Button Select (DVD)

Function : Selects the button (arrow key emulation)

Format : Integer CU

Explanation : The command selects the menu button displayed on the screen. The command emulates the “arrow” key on the remote control while the button exists on the screen. The command specifies the direction using four numbers:

Integer	directions
1	Up

2	Down
3	Left
4	Right

If the command is valid for the situation, the player immediately returns "R<CR>".*

If there are no buttons on the screen when the command is issued, an error message (E04) is returned.

*: However, this does not confirm that the command is executed completely.

Execution :

String	Status Return	DVD player
		Shows the disc menu
2CU<CR>	R<CR>	Moves the cursor down to the next button

6.34 Enter Button (DVD)

Function : sets the button and executes

Format : (Integer) ET

Explanation : The command fixes the button on the screen after executing the CU command with an integer. The player executes the program that is assigned to that button. This command emulates the "enter" key on the remote control while the button is on the screen.

If the command is appropriate for the situation, the player returns immediately "R<CR>".*

If there are no buttons on the screen when the command is issued, an error message (E04) is returned.

*: However, this does not confirm that the command is executed completely.

Execution :

String	Status Return	DVD player
		Shows the disc menu
2CU<CR>	R<CR>	Moves to the below button from the prior one
ET<CR>	R<CR>	Fixes the selection and executes the program that is assigned on it

Function : emulates the “left” click of the mouse

Format : argument1, argument2 ET

Explanation : The command emulates the “left” click of the mouse while the cursor is on the screen. The command specifies the position of the cursor with two arguments. The upper left on the screen is (0,0), the lower right on the screen is (719, 479) for NTSC playback, or (719, 575) for PAL. The format is stated below.

Argument1	Argument 2	Position
000000		Upper left limitation on the screen
	719479	Lower right limitation on the screen
X ₁ X ₂ X ₃ Y ₁ Y ₂ Y ₃		Anywhere on the screen

If the arguments are available, the player immediately returns “R<CR>”*.

If the argument number is unavailable, an error message (E06) is returned.

* The return “R<CR>” refers only to checking for an argument number. The player is incapable of verifying the existence of a button with this command.

Execution :

String	Status Return	DVD player
256384ET<CR>	R<CR>	Emulates the “left” click at the point (256,384) on the screen

6.35 Get Information (DVD)

Function : gets the disc information

Format : Integer GI

Explanation : The command, combined with a 4-digit ID and a 4-digit Sub-ID, returns the requested information to the player.

Integer = XXXXYYYY

ID (XXXX)	Sub-ID (YYYY)	Return Data from the Player
0000	Any number	E06 (argument error)
0001	0000 to 0023	System Parameter Info (4-digit)
0001	More than 0023	E06 (argument error)
00002 or more	Any number	E06 (argument error)

The player only returns system parameter information in cases where ID = 0001, otherwise the player returns error message E06.

Below is a list of the (SPRM) System Parameter. For more information, refer to "Table 4.6.1.2-1: System Parameters (SPRMs) in the DVD Specifications for a Read-Only Disc, (Part 3 VIDEO SPECIFICATIONS).

SPRM	Explanation
0	Menu Description Language Code (M_LCD)
1	Audio stream number (ASTN) for TT_DOM
2	Sub-picture stream number (SPSTN) & TT_DOM On/Off flag
3	Angle number (AGLN) for TT_DOM
4	Title number (TTN) for TT_DOM
5	VTS Title number (VTS_TTN) for TT_DOM
6	Title PGC number (TT_PGCN) for TT_DOM
7	Part_of_Title number (PTTN) for One_Sequential_PGC_Title
8	Highlighted Button number (HL_BTNN) for Selection state
9	Navigation Timer (NV_TMR)
10	TT_PGCN for NV_TMR
11	Player Audio Mixing Mode (P_AMXMD) for Karaoke
12	Country Code (CTY_LVL) for Parental Management
13	Parental Level (PTL_LVL)
14	Player Configuration (P_CFG) for Video
15	P_CFG for Audio
16	Initial Language Code (INI_LCD) for AST
17	INI_LCD_EXT for AST
18	INI_LCD for SPST
19	(INI_LCD_EXT) Initial Language Code extension for SPST
20	Player Region Code
21	reserved
22	reserved
23	reserved for extended playback mode

For example

SPRM(8): Highlighted Button number (HL_BTNN) for Selection state

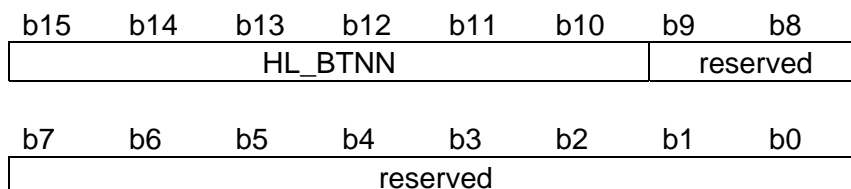

HL_BTNN..... 1 to 36: HL_BTNN value
 Others: reserved

Execution :

String	Status Return	DVD player
00010008GI<CR>	1400<CR>	Selecting button #5 now

6.36 Memory Data Upload

Function : reads the data from internal memory in a player

Format : MU

Explanation : The player, while in Park mode, sends the data to the computer with the total bytes equaling 11,358bytes

* 2,020bytes in data composed of Condition, Last memory (SETUP, ADV.SETUP, Error History, Program area, etc.)

* 9,332 bytes data such as Command Stack data

Both sets of information can be read at the same time.

The Communication flows as shown below.

(N=11,358)

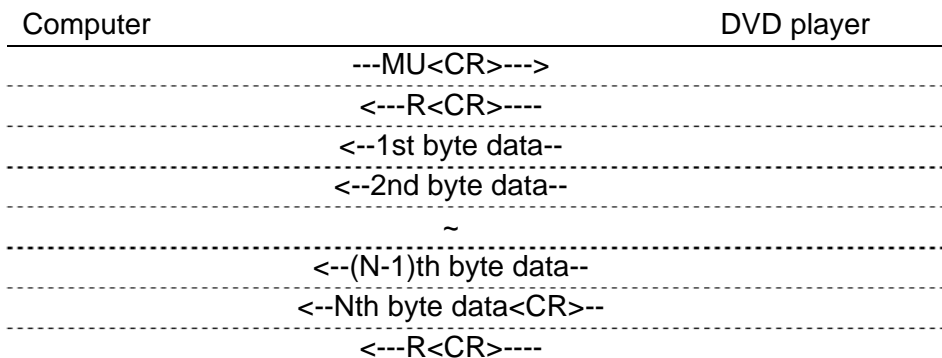

Format of the data:

BP	Contents	Numbers of bytes
0 - 1	(1) Total number of the transfer data (fixed number = 2C5Eh)	2 bytes
2 - 5	(2) 00000000	4 bytes
6 - 9	(3) Player ID (501571XX)	4 bytes
10 - 9,333	(4) Command Stack Data	9,324 bytes
9,334-9,361	(5) All FF	28 bytes
9,362 - 11,049	(6) Setup data	1904 bytes
11,266 - 11,285	(7) ADV.SETUP setting data	20 bytes
11,286 -	(8) Extend Terminal user setting data	60 bytes

11,345		
11,346	(9) Calibration data of touch device	1 Byte
11,347 - 11,349	(10) FFFFFFFh	3 Bytes
11350 - 11353	(11) 00000000	4 Bytes
11354 - 11357	(12) check sum	4 bytes

Execution :

String	Status Return	DVD player
		Park mode
MU<CR>	R<CR> ...(11,358 bytes)...<CR>	Receives the command and starts the transfer of the data, 11,358 bytes (ends with <CR>)
	R<CR>	

6.37 Return Firmware Version

Function : Returns player firmware version

Format : ?Z

Explanation : The command lists a number on the monitor which is the player's current firmware version.

Execution :

String	Status Return	DVD player
?Z<CR>	1.006	<i>Returns current firmware version</i>

7. OPERATING MODES

The Operating or Active mode consists of five sub-modes; Open, Park, Setup, Random Access and Reject. A command causes the player to change from one sub-mode to another. The five sub-modes are described below.

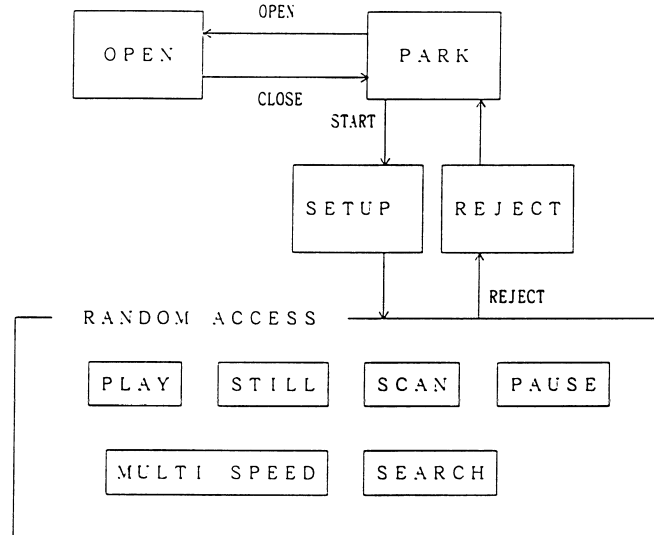

7.1 Open

The disc tray is open.

7.2 Park

The player enters the Park mode when the tray is closed.

7.3 Setup

If the Start command is sent while a disc is in the player, the disc spins up and the player proceeds to the Setup mode.

7.4 Random Access

The player enters the Random Access mode when the disc is ready for playback.

The Random Access mode is divided into six sub-modes; Play, Still, Scan, Pause, Multi Speed and Search. Various picture controls in the Random Access mode are available when playing a DVD or VCD disc. The effects are achieved through highly-detailed mode transfers. Refer to the previous figure for mode relationship information.

7.5 Reject

When the Reject command is sent to the player, video playback stops. Once the disc rotation has stopped, the player enters the Park mode.

8. DVD-V8000 INTERNAL REGISTERS

When arguments (e.g., Title number, Chapter number, Time Code, etc.), accompany commands to the player, argument values are set in the appropriate player registers. This Chapter describes each internal register of the player.

8.1 Current Time/Frame

The register contains the current time while a DVD disc is playing. A CD/VCD disc provides both a current Time Code and a Block number within the register.

8.2 P-TIME

The P-TIME Register contains the elapsed time within a Track or a Chapter.

8.3 Current Title/Track (Current Chapter)

The register contains the current Title/Track Number (Chapter Number).

8.4 Current Index

The register contains the current Index number.

8.5 Serial Digit Buffer

The register contains the command argument values. The commands are placed in a separate, exclusive register.

When the player evaluates a command, the contents of the buffer are transferred to a specified register.

8.6 Remote Control Use Address Flag

When a Search command is sent through the remote control to the player, a flag specifies if the address assigned is a Title/Track, Chapter, Time or Frame.

8.7 Remote Control Digit Buffer

The register contains the numbers input through the remote control.

8.8 Remote Control Data Register

The register contains the temporary data input through the remote control.

8.9 Serial Use Address Flag

When the Serial Interface controls the player, a flag specifies if the address assigned is a Title/Track, Chapter, Time or Frame.

8.10 Search Time/Frame

The register contains a goal Frame number or Time Code.

8.11 Search Title/Track (Search Chapter)

The register contains a goal Title/Track number (Chapter number) during a Search.

This function is identical to the Search Time/Frame (refer to 8.10).

8.12 Search Index

The register contains a goal Index number during a Search.

This function is identical to the Search Time/Frame command (refer to 8.11).

8.13 Mark Time/Frame

The register contains a marker (representing the Frame number or Time Code or Block number) which indicates the end point of an Auto Play.

When the player performs an Auto Play, the contents of the Mark Time/Frame and the Current Time/Frame are compared.

8.14 Mark Title/Track (Mark Chapter)

The register contains the Title/Track (mark Chapter) as a marker.

The function is identical to the Mark Time/Frame (refer to 8.12).

8.15 Mark Index

The register contains the Index number as a marker.

The function is identical to the Mark Time/Frame command (refer to 8.14).

8.16 Video Control

The player uses the register to control the Video ON/OFF switch.

8.17 Audio Control

The player uses the register to select the audio output.

8.18 Display Control

The player uses the register to toggle the Character Display switch ON/OFF.

The Character Display tracks on-screen information such as Time/Frame number, Title/Track number, etc.

8.19 Registers

There are two registers, A and D. The registers are reserved exclusively for CPU internal operations.

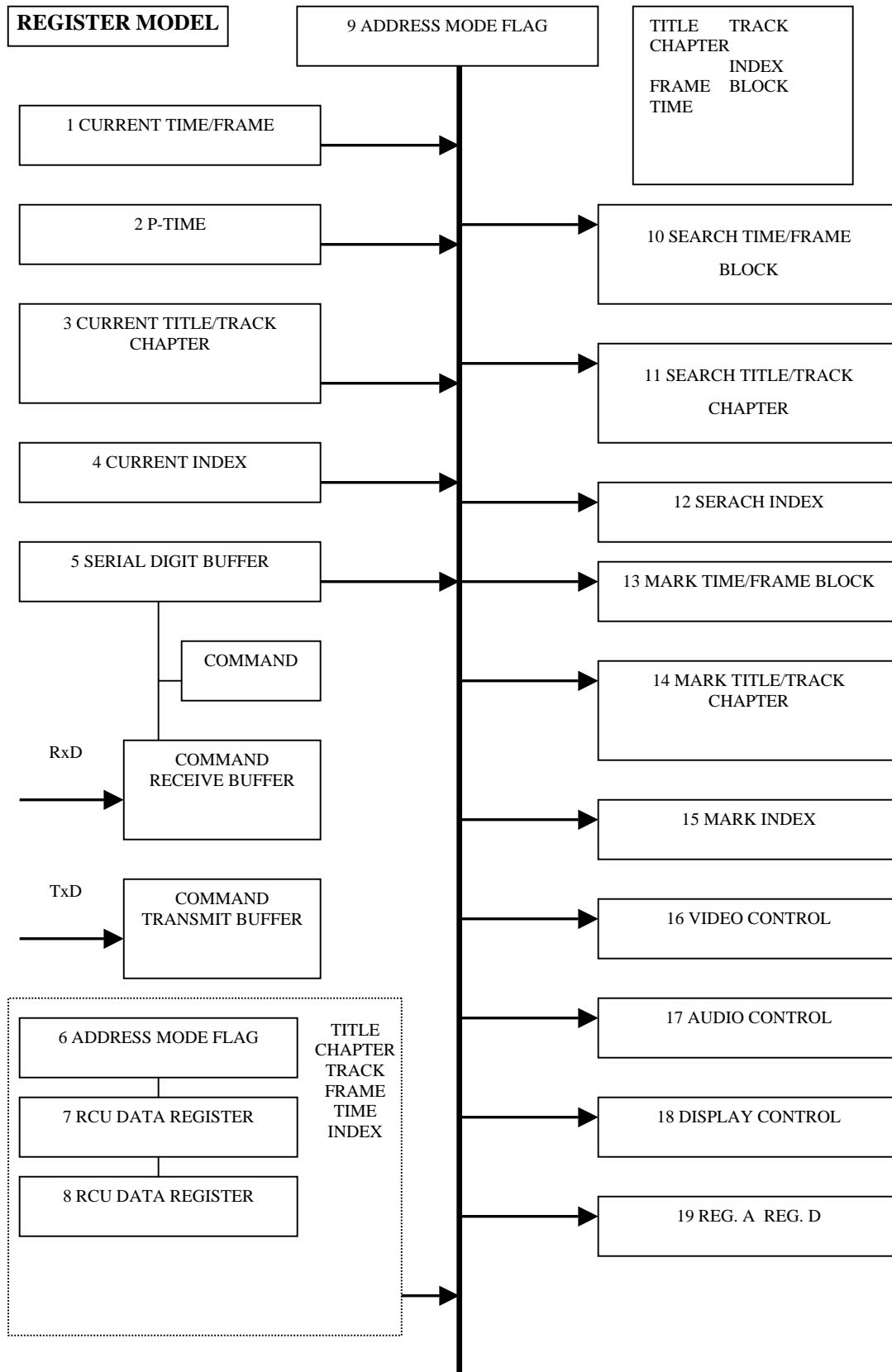

9. EXTEND TERMINAL CONTROL

To activate a function, create a switch contact with an electrical ground (Pin 1). Check Chapter 2 to verify pin (Pin 6 through Pin 13) and terminal (SW1 ~ SW8) assignments.

There are three SW functions in the EXTEND TERMINAL CONTROL.

1. To recall Command Stacks and execute

The function, STACK GROUP 1 to STACK GROUP 27, is similar to a combination of remote control buttons to recall and execute a stack.

2. To execute the function as a remote control command

The function acts the same as the buttons (ENTER, PLAY, STOP, etc.) on a remote control excluding SCAN FWD/REV.

DVD-V8000 continues execute SCAN FWD/REV even when the button on the remote control is released. But in case of EXTEND TERMINAL CONTROL, it stops to execute SCAN FWD/REV when button is released.

(In case of remote control “releasing SCAN button” will not discontinue the SCAN.

But in case of EXTEND TERMINAL, releasing SCAN switch will terminate SCAN operation.)

3. To execute as an advanced remote control button

Advanced remote control commands such as numbers from 10 to 20 may be sent as a switch control command.

[Note for additional assistance, please refer to Product Information Bulletin \(PIB\) 152601 DVD-V7400 and Jama Port Control](#) available on the Pioneer Electronics website under Service & Support – Business Solutions Products.

9.1 Function Assignment

Create a Circuit Controller or a Diode Matrix Circuit (refer to the table below).

Diode Assignment List (Standard setting and User default setting)

No.	SW1 ↑	SW2 ↓	SW3 ←	SW4 →	SW5 ENTER	SW6 X	SW7 Y	SW8 Z	Function
1	X								↑
2		X							↓
3			X						←
4				X					→
5					X				ENTER
6						X			STACK GROUP1
7							X		STACK GROUP2
8								X	STACK GROUP3
9		X						X	10
10			X					X	11
11				X				X	12
12	X	X							OPEN/CLOSE DISPLAY
13			X	X					
14	X					X			1
15		X				X			2
16			X			X			3
17				X		X			4
18	X						X		5
19		X					X		6
20	X			X					↗
21		X		X					↘
22		X	X						↙
23	X		X						↖
24					X	X			PLAY
25					X		X		STOP
26					X			X	PAUSE
27							X	X	TOP MENU
28			X				X		7
29				X			X		8
30	X							X	9
31					X	X	X		STEP FWD
32					X	X		X	STEP REV
33					X		X	X	RETURN
34	X	X	X						SCAN FWD
35	X	X		X					SCAN REV
36	X		X	X					SKIP FWD
37		X	X	X					SKIP REV
38			X			X	X		STACK GROUP4
39				X		X	X		STACK GROUP5
40	X	X					X		STACK GROUP6
41	X	X				X			13
42	X		X			X			14
43	X			X		X			15
44		X	X			X			16

Internal Registers

45		X		X		X			17
46			X	X		X			18
47	X					X	X		19
48		X				X	X		20
49	X		X				X		STACK GROUP7
50	X			X			X		STACK GROUP8
51		X	X				X		STACK GROUP9
52		X		X			X		STACK GROUP10
53			X	X			X		STACK GROUP11
54	X						X	X	STACK GROUP12
55		X					X	X	STACK GROUP13
56			X				X	X	STACK GROUP14
57				X			X	X	STACK GROUP15
58	X	X						X	STACK GROUP16
59	X		X					X	STACK GROUP17
60	X			X				X	STACK GROUP18
61		X	X					X	STACK GROUP19
62		X		X				X	STACK GROUP20
63			X	X				X	STACK GROUP21
64	X					X		X	STACK GROUP22
65		X				X		X	STACK GROUP23
66			X			X		X	STACK GROUP24
67				X		X		X	STACK GROUP25
68						X	X		STACK GROUP26
69						X		X	STACK GROUP27
70						X	X	X	MENU
71	X				X	X			RECALL
72	X				X		X		HOME MENU
73	X				X			X	MEMORY
74		X			X	X			>10
75		X			X		X		REPEAT
76		X			X			X	REPEAT A-B
77			X		X	X			AUDIO
78			X		X		X		ANGLE
79			X		X			X	SUBTITLE
80				X	X	X			TITLE/CHP/FRM/TIME
81				X	X		X		0
82				X	X			X	CLEAR

9.2 Function User Setting

Function assignment for No1 through 30 can be changed by user in advanced set up. The procedure is given below for an example of GROUP 3 setting change to "MENU".

- Open ADV SETUP and switch EXTEND TERMINAL to User and press Enter.
- And then the following window opens.

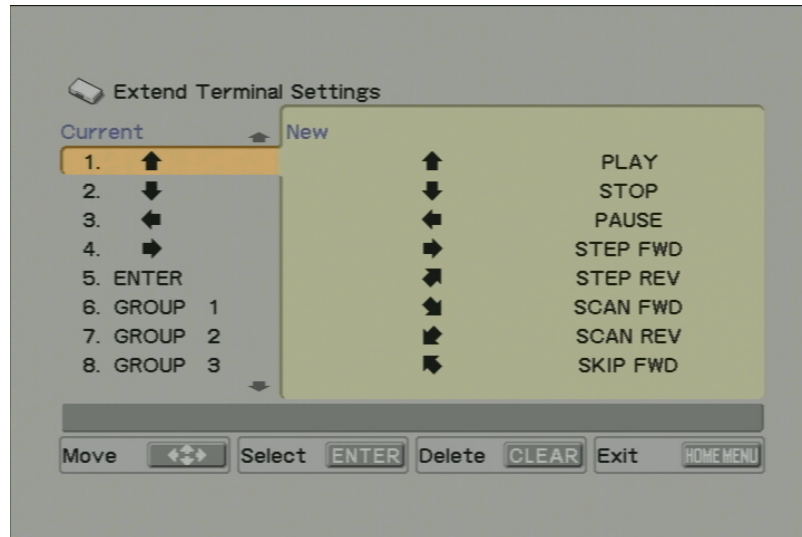

- DOWN button to select "GROUP 3"



- RIGHT Button

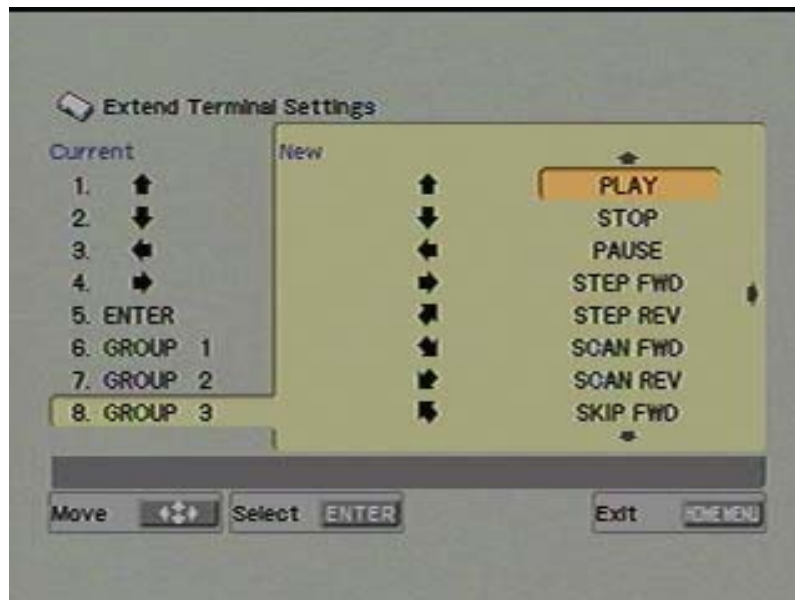

- DOWN Button to select "MENU"

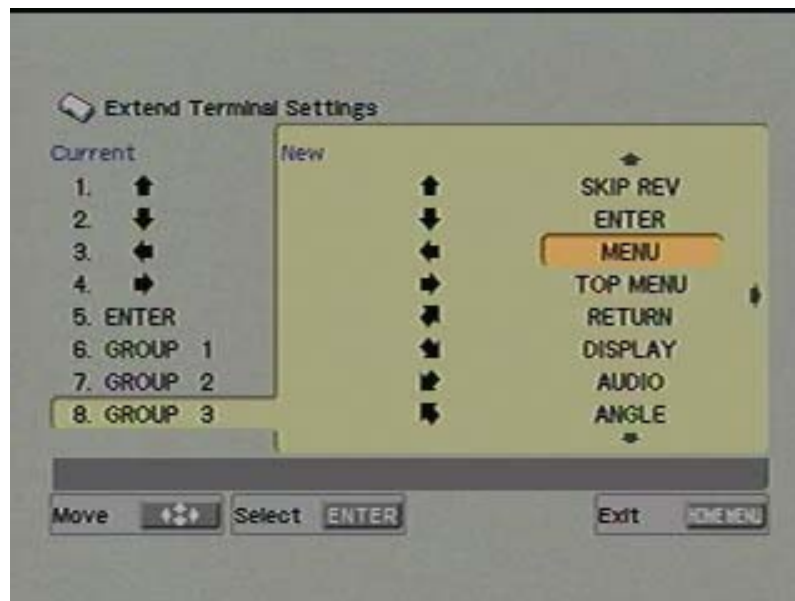

- ENTER button to change the function of switch 8 to MENU

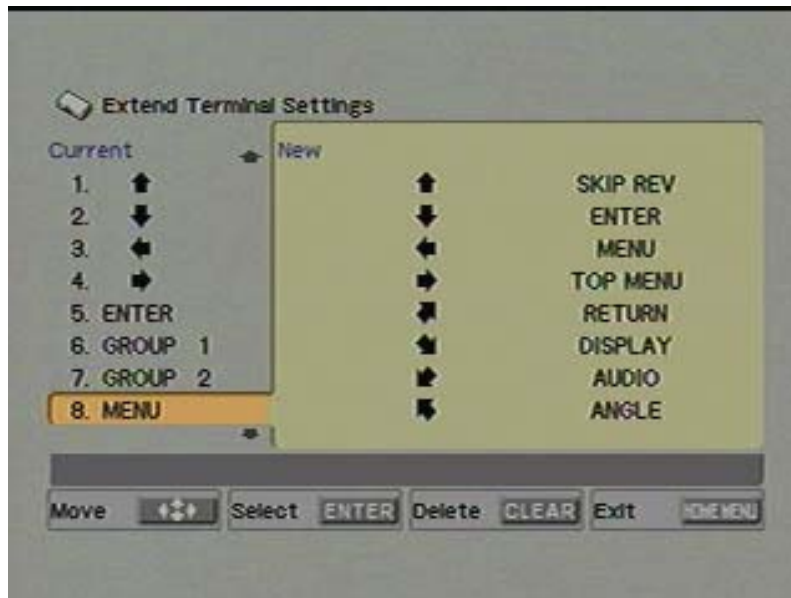

In order to DISABLE the switch function, please select the switch and Press "CLEAR" button. And then the switch will be displayed as "nothing" as shown below.

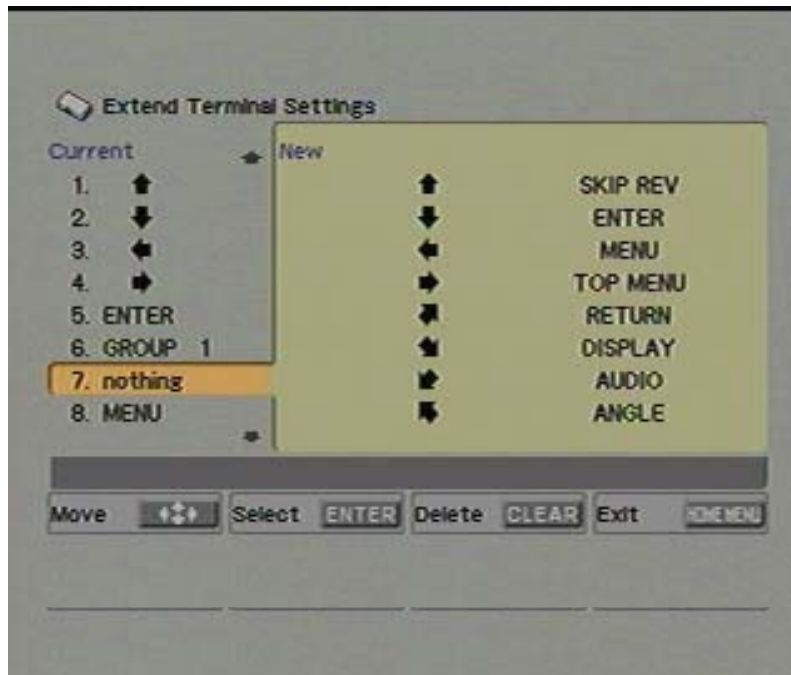

The modification of the switch setting will be reserved within memory area even with power-off.

In order to recover the initial factory setting, please select “Default Setting” and press ENTER.

For a initial setting, Standard and User are the same.

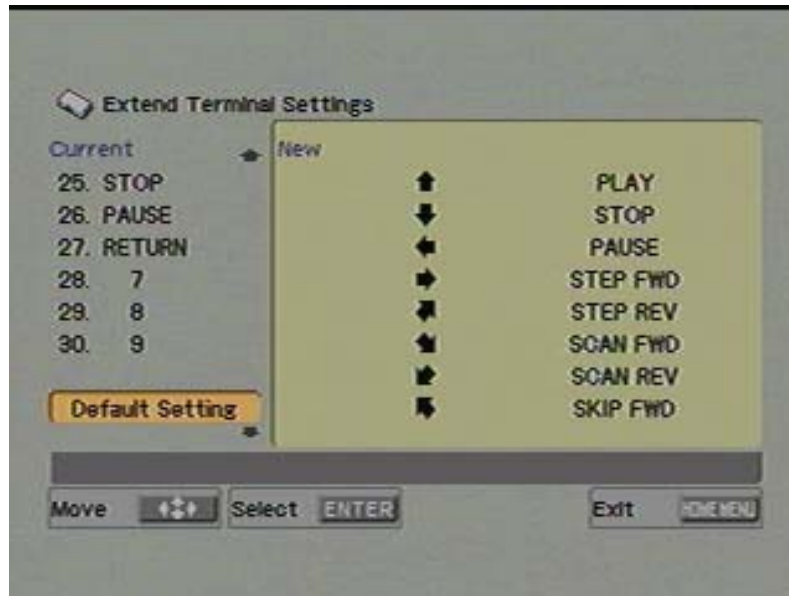

9.3 Controller

Examples of Switch and Diode specifications are charted below.

Switch Specifications

On Resistance	Less than 1 ohm
Off Resistance	More than 1 M ohm
Type	Non-Locking

Diode Specifications

Forward Voltage Drop (VF)	Less than 0.7 (IF 1mA)
Surge Forward Current (IFSM)	Less than 100mA
Forward Current	Less than 10µA

9.3.1 Simple Circuit

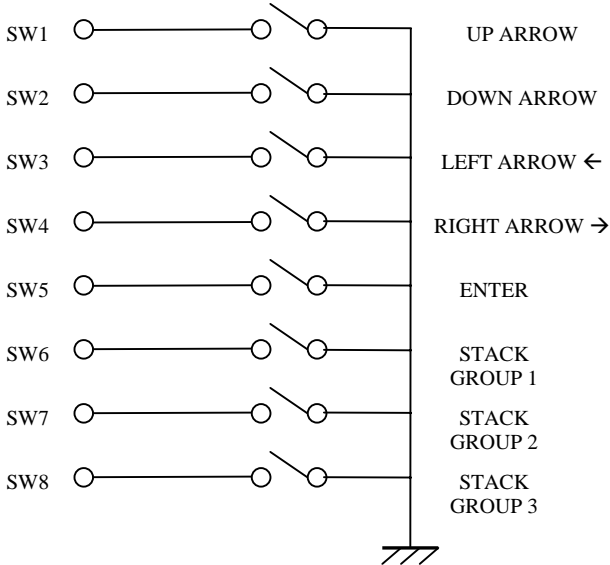

9.2.2 Diode Matrix Circuit

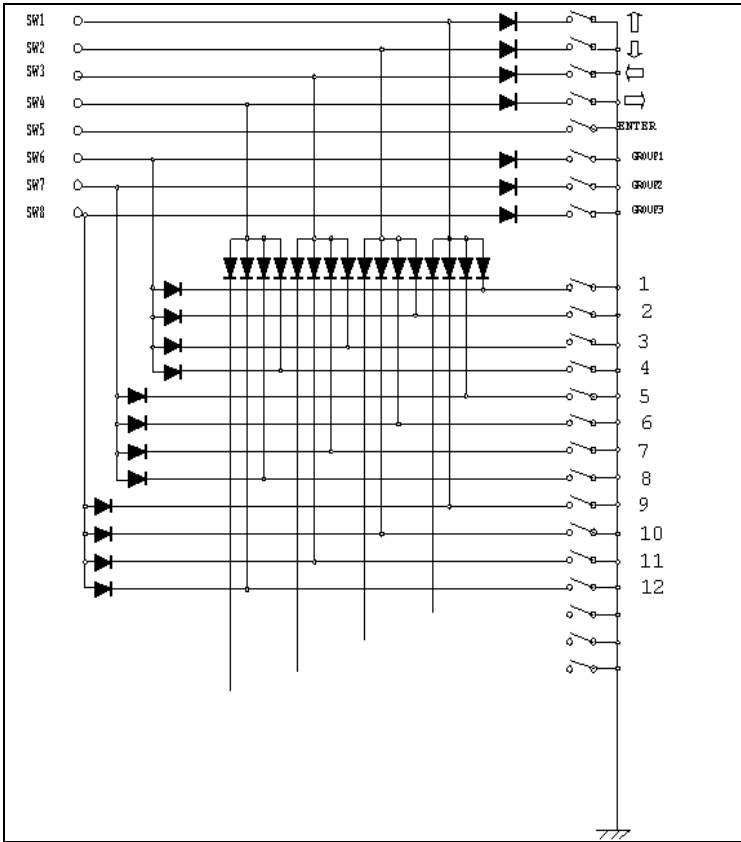

10. ADDITIONAL NOTES

1. If a video has a VOBU still, when the player reaches the VOBU still point, it enters the Still mode.
2. If Prohibit Pause is set for Stop Marker playback, an error is issued at any Stop Marker Point.
3. When a computer is controlling the player, send the KEY LOCK command to eliminate possible interference from the front panel buttons and/or the remote control.
4. If an invalid address is set within a command for a CD or VCD disc, the player returns an E04 error.

APPENDIX A - COMPLETE COMMAND LIST BY NAME

NOTE: arg or adrs (argument or address) prefaces commands with an argument or an address parameter. If arg or adrs is in (), then the parameter is optional.

COMMAND		SUPPORTING FORMATS		
Name	Mnemonic	DVD	CD	VCD
Audio Control	arg AD	x	x	x
Block Number	BK		x	
Block Number Request	?B		x	
Command Stack Play	arg BS	x		
CCR Mode Request	?M	x	x	x
CD Disc Status Request	?K		x	x
Chapter	CH	x		
Chapter Number Request	?C	x		
Chapter Skip	arg SK	x	x	x
Clear	CL	x	x	x
Clear Screen	CS	x	x	x
Close	CO	x	x	x
Command Stack Data Download	BD	x	x	x
Command Stack Data Upload	BU	x	x	x
Communication Control Set	arg CM	x	x	x
Current Address Request	?A	x	x	x
Disc Region code Request	?G	x		
Display Control	arg DS	x	x	X
DVD Disc Status Request	?V	x		
DVD VR Play Mode	arg VP	x		
Error Code Request	?E	x	x	X
Frame	FR	x		
Frame Number Request	?F	x		
General Purpose Parameter	>A, >B, ...>Z _A, _B, ... _Z <A, <B, ...<Z	x	x	x
Index	IX		x	
Index Number Request	?I		x	
Input Number Request	?N	x	x	x
Input Unit Request	#I	x	x	x
Key Lock	arg KL	x	x	x
Lead Out Symbol	LO	x	x	x
Multi-Speed Forward	(adrs) MF	x		x
Multi-Speed Reverse	(adrs) MR	x		
Open	OP	x	x	x
Output Select	arg OS	x	x	x
Pause	PA	x	x	x
Play	(adrs) PL	x	x	x

Complete Command List by Name

COMMAND		SUPPORTING FORMATS		
Name	Mnemonic	DVD	CD	VCD
Player Active Mode Request	?P	x	x	x
Player Model Name Request	?X	x	x	x
Player Region Code Request	?H	x	x	x
Print Character	arg PR	x	x	x
Register A Request	\$A	x	x	x
Register A Set (Display)	arg RA	x	x	x
Register D Request	\$D	x	x	x
Register D Set	arg RD	x	x	x
Reject	RJ	x	x	x
Repeat Mode	RM	x	x	x
Scan Forward	NF	x	x	x
Scan Reverse	NR	x	x	x
Scan Stop	NS	x	x	x
Search	adrs SE	x	x	x
Select Angle	arg AG	x		
Select Aspect	arg AP	x		
Select Audio	arg AU	x		
Select Subtitle	arg SU	x		
Speed	arg SP	x		x
Stack Group Set	arg GP	x		
Start	SA	x	x	x
Step Forward	SF	x		x
Step Reverse	SR	x		
Still	ST	x		x
Stop Marker	adrs SM	x	x	x
Time	TM	x	x	x
Time Code Request	?T	x	x	x
Title	TI	x		
Title/Track Number Request	?R	x	x	x
TOC Information Request	?Q	x	x	x
Track	TR		x	x
Video Control	arg VD	x	x	x

APPENDIX B - COMPLETE COMMAND LIST BY MNEMONIC

NOTE: arg or adrs (argument or address) prefaces commands with an argument or an address parameter. If arg or adrs is in (), then the parameter is optional.

COMMAND		SUPPORTING FORMATS		
Mnemonic	Name	DVD	CD	VCD
#I	Input Unit Request	x	x	x
\$A	Register A Request	x	x	x
\$D	Register D Request	x	x	x
<A, <B, ... <Z	General Purpose Parameter	x	x	x
>A, >B, ... >Z	General Purpose Parameter	x	x	x
?A	Current Address Request	x	x	x
?B	Block Number Request		x	
?C	Chapter Number Request	x		
?E	Error Code Request	x	x	x
?F	Frame Number Request	x		
?G	Disc Region code Request	x		
?H	Player Region Code Request	x	x	x
?I	Index Number Request		x	
?K	CD Disc Status Request		x	x
?M	CCR Mode Request	x	x	x
?N	Input Number Request	x	x	x
?P	Player Active Mode Request	x	x	x
?Q	TOC Information Request	x	x	x
?R	Title/Track Number Request	x	x	x
?T	Time Code Request	x	x	x
?V	DVD Disc Status Request	x		
?X	Player Model Name Request	x	x	x
?Z	Firmware Version Request	x		
arg AD	Audio Control	x	x	x
arg AG	Select Angle	x		
arg AP	Select Aspect	x		
arg AU	Select Audio	x		
BD	Command Stack Data Download	x	x	x
BK	Block Number		x	
arg BS	Command Stack Play	x		
BU	Command Stack Data Upload	x	x	x
CH	Chapter	x		
CL	Clear	x	x	x
arg CM	Communication Control Set	x	x	x
CO	Close	x	x	x
CS	Clear Screen	x	x	x
arg DS	Display Control	x	x	x
FR	Frame	x		
arg GP	Stack Group Set	x	x	x
IX	Index		x	

Complete Command List by Mnemonic

COMMAND			SUPPORTING FORMATS		
Mnemonic	Name	DVD	CD	VCD	
arg	KL	Key Lock	x	x	x
	LO	Lead Out Symbol	x	x	x
(adrs)	MF	Multi-Speed Forward	x		x
(adrs)	MR	Multi-Speed Reverse	x		
	NF	Scan Forward	x	x	x
	NR	Scan Reverse	x	x	x
	NS	Scan Stop	x	x	x
	OP	Open	x	x	x
arg	OS	Output Select	x	x	x
	PA	Pause	x	x	x
(adrs)	PL	Play	x	x	x
arg	PR	Print Character	x	x	x
arg	RA	Register A Set (Display)	x	x	x
arg	RD	Register D Set	x	x	x
	RJ	Reject	x	x	x
	RM	Repeat Mode	x	x	x
	SA	Start	x	x	x
adrs	SE	Search	x	x	x
	SF	Step Forward	x		x
arg	SK	Chapter Skip	x	x	x
adrs	SM	Stop Marker	x	x	x
arg	SP	Speed	x		x
	SR	Step Reverse	x		
	ST	Still	x		x
arg	SU	Select Subtitle	x		
	TI	Title	x		
	TM	Time	x	x	x
	TR	Track		x	x
arg	VD	Video Control	x	x	x
arg	VP	DVD VR Play Mode	x		

APPENDIX C - DVD COMMAND LIST

NOTE: arg or adrs (argument or address) prefaces commands with an argument or an address parameter. If arg or adrs is in (), then the parameter is optional.

COMMAND	
Name	Mnemonic
Audio Control	arg AD
Command Stack Data Download	BD
Command Stack Data Upload	BU
Command Stack Play	arg BS
CCR Mode Request	?M
Chapter	CH
Chapter Number Request	?C
Clear	CL
Clear Screen	CS
Close	CO
Communication Control Set	arg CM
Current Address Request	?A
Disc Region code Request	?G
Display Control	arg DS
DVD Disc Status Request	?V
DVD VR Play Mode	arg VP
Error Code Request	?E
Firmware Version	?Z
Frame	FR
Frame Number Request	?F
General Purpose Parameter	>A, >B, ... >Z _A, _B, ... _Z <A, <B, ... <Z
Input Number Request	?N
Input Unit Request	#I
Key Lock	arg KL
Lead Out Symbol	LO
Multi-Speed Forward	(adrs) MF
Multi-Speed Reverse	(adrs) MR
Open	OP
Output Select	arg OS
Pause	PA
Play	(adrs) PL
Player Active Mode Request	?P
Player Model Name Request	?X
Player Region Code Request	?H
Print Character	arg PR
Register A Request	\$A
Register A Set (Display)	arg RA

COMMAND	
Mnemonic	Name
Register D Request	\$D
Register D Set	arg RD
Reject	RJ
Repeat Mode	RM
Scan Forward	NF
Scan Reverse	NR
Scan Stop	NS
Search	adrs SE
Select Angle	arg AG
Select Aspect	arg AP
Select Audio	arg AU
Select Subtitle	arg SU
Speed	arg SP
Stack Group Set	arg GP
Start	SA
Step Forward	SF
Step Reverse	SR
Still	ST
Stop Marker	adrs SM
Time	TM
Time Code Request	?T
Title	TI
Title/Track Number Request	?R
Toc Information Request	?Q
Video Control	arg VD

APPENDIX D - CD COMMAND LIST

NOTE: arg or adrs (argument or address) prefaces commands with an argument or an address parameter. If arg or adrs is in (), then the parameter is optional.

COMMAND	
Name	Mnemonic
Audio Control	arg AD
Block Number	BK
Block Number Request	?B
Command Stack Data Download	BD
Command Stack Data Upload	BU
CCR Mode Request	?M
CD Disc Status Request	?K
Chapter Skip	arg SK
Clear	CL
Clear Screen	CS
Close	CO
Communication Control Set	arg CM
Current Address Request	?A
Display Control	arg DS
Error Code Request	?E
General Purpose Parameter	>A, >B, ... >Z _A, _B, ... _Z <A, <B, ... <Z
Index	IX
Index Number Request	?I
Input Number Request	?N
Input Unit Request	#I
Key Lock	arg KL
Lead Out Symbol	LO
Open	OP
Output Select	arg OS
Pause	PA
Play	(adrs) PL
Player Active Mode Request	?P
Player Model Name Request	?X
Player Region Code Request	?H
Print Character	arg PR
Register A Request	\$A
Register A Set (Display)	arg RA
Register D Request	\$D
Register D Set	arg RD
Reject	RJ
Scan Forward	NF
Scan Reverse	NR
Scan Stop	NS
Search	adrs SE

Stack Group Set	arg	GP
Start		SA
Stop Marker	adrs	SM
Time		TM
Time Code Request		?T
Title/Track Number Request		?R
TOC Information Request		?Q
Track		TR
Video Control	arg	VD

APPENDIX E - VCD COMMAND LIST

NOTE: arg or adrs (argument or address) prefaces commands with an argument or an address parameter. If arg or adrs is in (), then the parameter is optional.

COMMAND	
Name	Mnemonic
Audio Control	arg AD
Command Stack Data Download	BD
Command Stack Data Upload	BU
CCR Mode Request	?M
CD Disc Status Request	?K
Chapter Skip	arg SK
Clear	CL
Clear Screen	CS
Close	CO
Communication Control Set	arg CM
Current Address Request	?A
Display Control	arg DS
Error Code Request	?E
General Purpose Parameter	>A, >B, ... >Z _A, _B, ... _Z <A, <B, ... <Z
Input Number Request	?N
Input Unit Request	#I
Key Lock	arg KL
Lead Out Symbol	LO
Player Model Name Request	?X
Multi-Speed Forward	(adrs) MF
Open	OP
Output Select	arg OS
Pause	PA
Play	(adrs) PL
Player Active Mode Request	?P
Player Model Name Request	?X
Player Region Code Request	?H
Print Character	arg PR
Register A Request	\$A
Register A Set (Display)	arg RA
Register D Request	\$D
Register D Set	arg RD
Reject	RJ
Scan Forward	NF
Scan Reverse	NR
Scan Stop	NS
Search	adrs SE
Speed	arg SP
Start	SA

COMMAND	
Mnemonic	Name
Step Forward	SF
Still	ST
Stop Marker	adrs SM
Time	TM
Time Code Request	?T
Title/Track Number Request	?R
TOC Information Request	?Q
Track	TR
Video Control	arg VD

APPENDIX F - ERROR CODES

Code	Message	Description
E00	communication error	Communication Line Error due to framing error or buffer overflow.
E04	feature not available	Non-Usable Function has been tried. Either the command mnemonic is wrong or the command can not be used in this mode.
E06	missing argument	Necessary parameter is not specified.
E11	disc does not exist	There is no disc in the tray.
E12	Search error	Search address can not be found.
E15	picture stop	Playback has been stopped by VOBUs Still while in auto play mode.
E16	interrupt by other device	The command(s) sent via the serial line were not executed before commands were sent from the front panel buttons and/or remote control.
E99	Panic	Unrecoverable Error occurred. Is possible a disc can not be loaded and/or playing can not continue.

APPENDIX G - SPECIFICATIONS OF RS-232 TRANSCEIVER

PARAMETERS	MIN.	TYP.	MAX.	UNITS	CONDITIONS
RS-232 OUTPUTS					
Output Voltage Swing	± 5	± 9		Volts	All transmitter outputs loaded with 3k Ω to Ground
Output Resistance	300			Ohms	$V_{cc}=0V$, $V_{out}=\pm 2V$
Output Short Circuit Current		± 18		mA	Infinite duration
RS-232 INPUT					
Voltage Range	-15		+15	Volts	
Voltage Threshold					
LOW	0.8	1.2		Volts	$V_{cc}=5V$, $T_a=+25^\circ C$
HIGH		1.7	2.8	Volts	$V_{cc}=5V$, $T_a=+25^\circ C$
Resistance	3	5	7	k Ω	$T_a=+25^\circ C$, $-15V \leq V_{in} \leq +15V$

DVD-V8000

Industrial DVD Player RS-232 Command Protocol

Pioneer Electronic Corporation
4-1, Meguro 1-chome
Meguro-ku, Tokyo 153
JAPAN
<http://pioneer.jp>

Pioneer Electronics (USA), Inc.
Business Solutions Division
2265 East 220th Street
Long Beach, California 90810
United States of America
(310) 952-2000
<http://www.pioneerelectronics.com>